

The how-to magazine of electronics...

ELECTRONICTM

Servicing & Technology

DECEMBER 1986/\$2.25

Index of 1986 articles • 51-month Profax index

Troubleshooting audio equipment Supertech style

TV troubleshooting hints and tips



LEADER

LBO-516 NEW 100-MHz OSCILLOSCOPE \$1395 Manufacturer's Suggested List Price

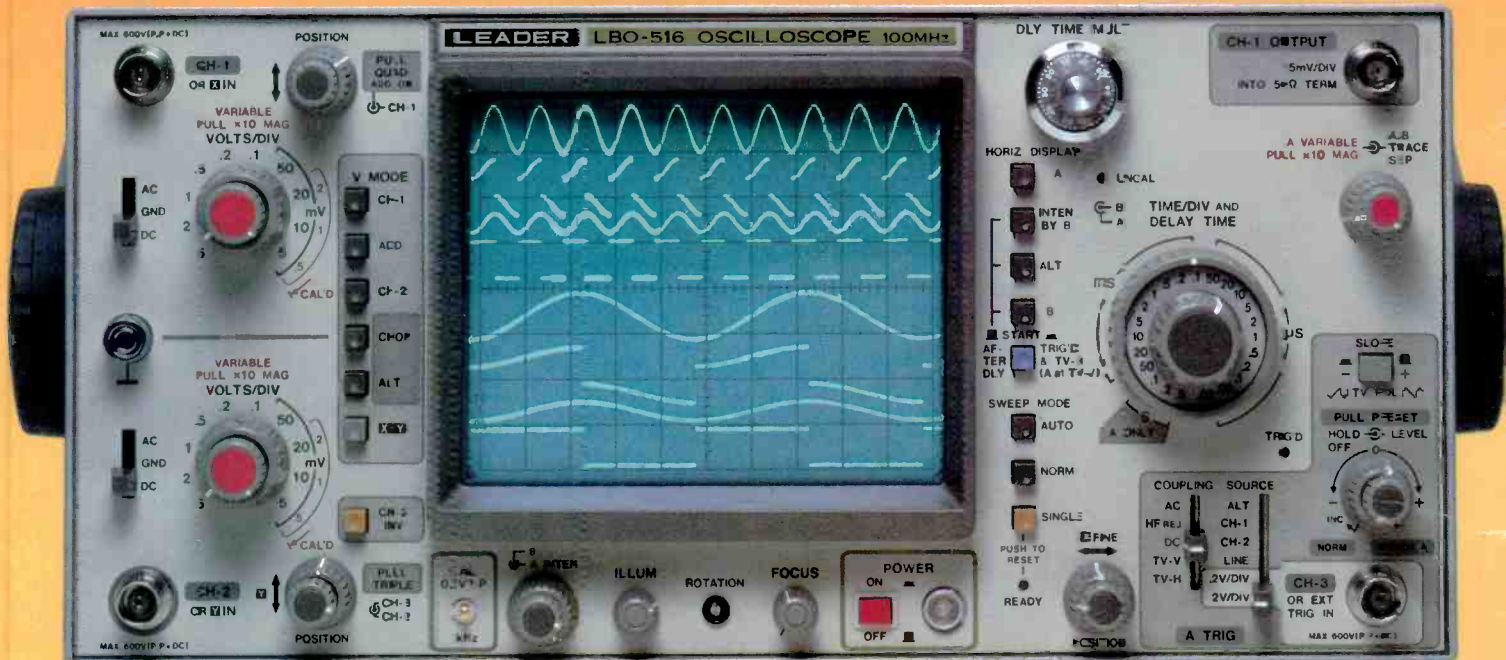

✓ 8-Trace Capability

✓ Alternate Triggering

✓ 2 Time Bases

✓ 3-Channel Input

✓ Clear, Bright Trace

✓ 0.5 mV Sensitivity

✓ 2-Year Warranty

✓ Coast-to-Coast Service

For immediate delivery or more information call toll-free

✓ **800-645-5104**

In New York State
516-231-6900

For professionals who know the difference.

LEADER
Instruments Corporation

380 Oser Ave., Hauppauge, NY 11788

For Information Circle (1) on Reply Card
For Demonstration Circle (2) on Reply Card

WANT FREE, QUICK INFORMATION? USE THESE READER SERVICE CARDS...

- 1 Attach your peel-off label from the cover to address box on card, or print your name, title, company, address, Zip Code and phone number.
- 2 Sign and date the card.

- 3 Circle the number (or numbers) on the card corresponding to the number at the bottom of each advertisement or editorial item for which you want more information.

- 4 Use card to start or renew your subscription to ES&T.
- 5 Affix postage stamp and mail right away.

ELECTRONIC

Service & Technology

READER SERVICE INFORMATION AND SUBSCRIPTION SERVICE CARD

For issue of December 1986
Void after April 1, 1987

FOR FASTER ACTION!

I have an immediate interest in the items I've indicated here. Please have a salesperson call me.

RD6

For more information on products or services mentioned in this issue, simply circle the appropriate numbers below.

- | | | | | | | | | | | | | | | | | | | | |
|-----|-----|-----|-----|-----|-----|-----|-----|-----|-----|-----|-----|-----|-----|-----|-----|-----|-----|-----|-----|
| 1 | 2 | 3 | 4 | 5 | 6 | 7 | 8 | 9 | 10 | 11 | 12 | 13 | 14 | 15 | 16 | 17 | 18 | 19 | 20 |
| 21 | 22 | 23 | 24 | 25 | 26 | 27 | 28 | 29 | 30 | 31 | 32 | 33 | 34 | 35 | 36 | 37 | 38 | 39 | 40 |
| 41 | 42 | 43 | 44 | 45 | 46 | 47 | 48 | 49 | 50 | 51 | 52 | 53 | 54 | 55 | 56 | 57 | 58 | 59 | 60 |
| 61 | 62 | 63 | 64 | 65 | 66 | 67 | 68 | 69 | 70 | 71 | 72 | 73 | 74 | 75 | 76 | 77 | 78 | 79 | 80 |
| 81 | 82 | 83 | 84 | 85 | 86 | 87 | 88 | 89 | 90 | 91 | 92 | 93 | 94 | 95 | 96 | 97 | 98 | 99 | 100 |
| 101 | 102 | 103 | 104 | 105 | 106 | 107 | 108 | 109 | 110 | 111 | 112 | 113 | 114 | 115 | 116 | 117 | 118 | 119 | 120 |
| 121 | 122 | 123 | 124 | 125 | 126 | 127 | 128 | 129 | 130 | 131 | 132 | 133 | 134 | 135 | 136 | 137 | 138 | 139 | 140 |
| 141 | 142 | 143 | 144 | 145 | 146 | 147 | 148 | 149 | 150 | 151 | 152 | 153 | 154 | 155 | 156 | 157 | 158 | 159 | 160 |
| 161 | 162 | 163 | 164 | 165 | 166 | 167 | 168 | 169 | 170 | 171 | 172 | 173 | 174 | 175 | 176 | 177 | 178 | 179 | 180 |
| 181 | 182 | 183 | 184 | 185 | 186 | 187 | 188 | 189 | 190 | 191 | 192 | 193 | 194 | 195 | 196 | 197 | 198 | 199 | 200 |

Please print Name _____ Title _____

Company Name _____

Address _____

City _____ State _____ Zip _____

BUSINESS TELEPHONE: AREA CODE () NUMBER _____

Signature _____ Date _____

Please check one box under each () to expedite your request for information.

- | | |
|--|--|
| <input type="radio"/> Type of Business
21 <input type="checkbox"/> Consumer Electronics Equipment Independent or Franchised Service Business
22 <input type="checkbox"/> Retailer With Consumer Electronics Equipment Service Department
23 <input type="checkbox"/> Electronics Equipment Field Service Organization
24 <input type="checkbox"/> Service, Installation or Operation of Electronics Equipment In Industrial Or Commercial Facility
33 <input type="checkbox"/> Engineering Of Electronics Equipment In Industrial Or Commercial Facility
35 <input type="checkbox"/> Wholesaler, Jobber, Distributor
37 <input type="checkbox"/> Electronics Equipment Or Components Manufacturer
38 <input type="checkbox"/> Government and Military: Federal, State, Municipal
09 <input type="checkbox"/> Education
(a) <input type="checkbox"/> College, Library, School, Including Instructors
(b) <input type="checkbox"/> Student
30 <input type="checkbox"/> Other | <input type="radio"/> Position
EE <input type="checkbox"/> Company Management Such as General Manager, Owner, Partner, President, Vice President, Director And Other Corporate Personnel
FF <input type="checkbox"/> Operations Management Such as Service Manager, Operations Manager, Production Manager, Customer Service Manager, Marketing/Sales Manager, Purchasing Manager, Credit/Accounts Manager and Other Operations/Administrative Personnel
GG <input type="checkbox"/> Engineering/Technical & Other Personnel Such as Engineer, Technician, Field Service Engineer, Specialist, Engineering Associate and Other Engineering And Technical Support Personnel
KK <input type="checkbox"/> Other |
|--|--|
- Check the number of Service Technicians employed at your facility.
- | | |
|----------------------------------|---|
| A <input type="checkbox"/> 1-5 | D <input type="checkbox"/> 26-50 |
| B <input type="checkbox"/> 6-10 | E <input type="checkbox"/> Over 50 |
| C <input type="checkbox"/> 11-25 | F <input type="checkbox"/> Not applicable |
- Check the statement that best describes your role in the purchase of major electronics servicing equipment and servicing components, accessories and services.
- 1 Make final decision to buy a specific make or model.
 2 Recommend make or model to be purchased.
 3 Have no part in specifying or buying.

SUBSCRIBE NOW!

- Year Biggest Savings!*
- 1 Year - 12 issues ONLY \$18.00
 - 2 Years - 24 issues ONLY \$30.00
 - 3 Years - 36 issues ONLY \$38.00
- Please check preferred order (Allow 6-8 weeks for delivery of first issue)

Note: Outside U.S.A. rates are: 1 Year \$22 2 Years \$34 3 Years \$44

- Payment enclosed
- Charge to my VISA/MASTERCARD
- Bill me later

CHARGE TO MY: (Please check one)

MASTERCARD VISA

ACCOUNT NUMBER									
INTERBANK NUMBER								CARD EXPIRES	
MASTER CHARGE ONLY (4 digits above your name)								MO.	YR.

Signature required _____ Date _____

ELECTRONIC

Service & Technology

READER SERVICE INFORMATION AND SUBSCRIPTION SERVICE CARD

For issue of December 1986
Void after April 1, 1987

FOR FASTER ACTION!

I have an immediate interest in the items I've indicated here. Please have a salesperson call me.

RD6

For more information on products or services mentioned in this issue, simply circle the appropriate numbers below.

- | | | | | | | | | | | | | | | | | | | | |
|-----|-----|-----|-----|-----|-----|-----|-----|-----|-----|-----|-----|-----|-----|-----|-----|-----|-----|-----|-----|
| 1 | 2 | 3 | 4 | 5 | 6 | 7 | 8 | 9 | 10 | 11 | 12 | 13 | 14 | 15 | 16 | 17 | 18 | 19 | 20 |
| 21 | 22 | 23 | 24 | 25 | 26 | 27 | 28 | 29 | 30 | 31 | 32 | 33 | 34 | 35 | 36 | 37 | 38 | 39 | 40 |
| 41 | 42 | 43 | 44 | 45 | 46 | 47 | 48 | 49 | 50 | 51 | 52 | 53 | 54 | 55 | 56 | 57 | 58 | 59 | 60 |
| 61 | 62 | 63 | 64 | 65 | 66 | 67 | 68 | 69 | 70 | 71 | 72 | 73 | 74 | 75 | 76 | 77 | 78 | 79 | 80 |
| 81 | 82 | 83 | 84 | 85 | 86 | 87 | 88 | 89 | 90 | 91 | 92 | 93 | 94 | 95 | 96 | 97 | 98 | 99 | 100 |
| 101 | 102 | 103 | 104 | 105 | 106 | 107 | 108 | 109 | 110 | 111 | 112 | 113 | 114 | 115 | 116 | 117 | 118 | 119 | 120 |
| 121 | 122 | 123 | 124 | 125 | 126 | 127 | 128 | 129 | 130 | 131 | 132 | 133 | 134 | 135 | 136 | 137 | 138 | 139 | 140 |
| 141 | 142 | 143 | 144 | 145 | 146 | 147 | 148 | 149 | 150 | 151 | 152 | 153 | 154 | 155 | 156 | 157 | 158 | 159 | 160 |
| 161 | 162 | 163 | 164 | 165 | 166 | 167 | 168 | 169 | 170 | 171 | 172 | 173 | 174 | 175 | 176 | 177 | 178 | 179 | 180 |
| 181 | 182 | 183 | 184 | 185 | 186 | 187 | 188 | 189 | 190 | 191 | 192 | 193 | 194 | 195 | 196 | 197 | 198 | 199 | 200 |

Please print Name _____ Title _____

Company Name _____

Address _____

City _____ State _____ Zip _____

BUSINESS TELEPHONE: AREA CODE () NUMBER _____

Signature _____ Date _____

Please check one box under each () to expedite your request for information.

- | | |
|--|--|
| <input type="radio"/> Type of Business
21 <input type="checkbox"/> Consumer Electronics Equipment Independent or Franchised Service Business
22 <input type="checkbox"/> Retailer With Consumer Electronics Equipment Service Department
23 <input type="checkbox"/> Electronics Equipment Field Service Organization
24 <input type="checkbox"/> Service, Installation or Operation of Electronics Equipment In Industrial Or Commercial Facility
33 <input type="checkbox"/> Engineering Of Electronics Equipment In Industrial Or Commercial Facility
35 <input type="checkbox"/> Wholesaler, Jobber, Distributor
37 <input type="checkbox"/> Electronics Equipment Or Components Manufacturer
38 <input type="checkbox"/> Government and Military: Federal, State, Municipal
09 <input type="checkbox"/> Education
(a) <input type="checkbox"/> College, Library, School, Including Instructors
(b) <input type="checkbox"/> Student
30 <input type="checkbox"/> Other | <input type="radio"/> Position
EE <input type="checkbox"/> Company Management Such as General Manager, Owner, Partner, President, Vice President, Director And Other Corporate Personnel
FF <input type="checkbox"/> Operations Management Such as Service Manager, Operations Manager, Production Manager, Customer Service Manager, Marketing/Sales Manager, Purchasing Manager, Credit/Accounts Manager and Other Operations/Administrative Personnel
GG <input type="checkbox"/> Engineering/Technical & Other Personnel Such as Engineer, Technician, Field Service Engineer, Specialist, Engineering Associate and Other Engineering And Technical Support Personnel
KK <input type="checkbox"/> Other |
|--|--|
- Check the number of Service Technicians employed at your facility.
- | | |
|----------------------------------|---|
| A <input type="checkbox"/> 1-5 | D <input type="checkbox"/> 26-50 |
| B <input type="checkbox"/> 6-10 | E <input type="checkbox"/> Over 50 |
| C <input type="checkbox"/> 11-25 | F <input type="checkbox"/> Not applicable |
- Check the statement that best describes your role in the purchase of major electronics servicing equipment and servicing components, accessories and services.
- 1 Make final decision to buy a specific make or model.
 2 Recommend make or model to be purchased.
 3 Have no part in specifying or buying.

SUBSCRIBE NOW!

- Year Biggest Savings!*
- 1 Year - 12 issues ONLY \$18.00
 - 2 Years - 24 issues ONLY \$30.00
 - 3 Years - 36 issues ONLY \$38.00
- Please check preferred order (Allow 6-8 weeks for delivery of first issue)

Note: Outside U.S.A. rates are: 1 Year \$22 2 Years \$34 3 Years \$44

- Payment enclosed
- Charge to my VISA/MASTERCARD
- Bill me later

CHARGE TO MY: (Please check one)

MASTERCARD VISA

ACCOUNT NUMBER									
INTERBANK NUMBER								CARD EXPIRES	
MASTER CHARGE ONLY (4 digits above your name)								MO.	YR.

Signature required _____ Date _____

The how-to
magazine
of
electronics...

...brings
you current
information
on:

- Personal/
Home Computers
- VCRs
- TVs
- Audio Equipment
- Video Games
- Satellite Dishes
- Microwaves

*New Technology
and service
data in every
issue...
Plus how-to
articles with
charts,
graphs, pictures
and schematics.*

**SUBSCRIBE
NOW!**

Tell us what you think about this issue?

What was the most interesting article in this issue?

List the subjects you want to read about most?

Which one advertisement in this issue was of most
interest to you?

Advertiser's name _____

Circle No. _____



PLACE
FIRST CLASS
POSTAGE
HERE

ELECTRONIC
Servicing & Technology

Product Information
P.O. Box 12951
Overland Park, KS 66212-0951



Tell us what you think about this issue?

What was the most interesting article in this issue?

List the subjects you want to read about most?

Which one advertisement in this issue was of most
interest to you?

Advertiser's name _____

Circle No. _____



PLACE
FIRST CLASS
POSTAGE
HERE

ELECTRONIC
Servicing & Technology

Product Information
P.O. Box 12951
Overland Park, KS 66212-0951



Fluke breaks the old mold.



The Fluke 37. A bold new shape emerges with more features for the money than any other bench DMM. Period.

Dollar for dollar, the new Fluke 37 is unbeatable. In addition to its breakthrough design — with built-in handle and storage compartment — it has all the high-performance features of the world's best, most reliable 3½ digit DMMs.

Autoranging, to eliminate guesswork. Audible Continuity, so you don't have to look at the display. An exclusive analog and digital display, for the best view of the signal being measured. Superior EMI shielding. And user-friendly features like auto self-test, auto battery test and auto-polarity. All this, *plus* a two-year warranty.

And, how many other \$229 bench meters give you these features? Min-Max recording, for monitoring signals. 38 components dedicated exclusively to input protection. Relative mode, to help you calculate changes in readings. And Fluke's patented Touch Hold, to give you an extra set of hands when you're taking critical measurements.

None. Not at \$229. Not at *any* price. For your nearest distributor or a free brochure, call toll-free *anytime* **1-800-227-3800, Ext. 229.** (Outside the U.S., call 1-402-496-1350, Ext. 229.)

FROM THE WORLD LEADER IN DIGITAL MULTIMETERS.



FLUKE 37

\$229*
0.1% basic dc accuracy
Analog/Digital Display
Volts, Ohms, Amps, Diode Test
30 kHz AC bandwidth
Fused 10A Range
Integral handle, storage compartment
2-year warranty

* Suggested U.S. list price, effective June 1, 1986.



IN THE U.S. AND NON-EUROPEAN COUNTRIES: John Fluke Mfg. Co., Inc., P.O. Box C909C, M/S 250C, Everett, WA 98206. Sales (206) 356-5400. Other (206) 347-6100. EUROPEAN HEADQUARTERS: Fluke (Holland) B.V., P.O. Box 2269, 5800 CG Eindhoven, The Netherlands. (040) 458045. TLX 51846. © Copyright 1986 John Fluke Mfg. Co., Inc. All rights reserved. Ad No. 4701-37

Circle (4) on Reply Card

ELECTRONIC

Servicing & Technology

Volume 6, No. 12 December 1986

14

TV troubleshooting hints and tips

By Conrad Persson

When diagnosing an ailing television, weigh symptoms and test vital signs as methodically as does a physician whose concern is a human patient.

20

Watch your language!

By Conrad Persson

With every electronics advancement, comes a brand-new vocabulary that must be learned before comprehending the accompanying new concepts, new materials and brand-new techniques.

22

Index of 1986 articles and 50-month Profax directory

Compiled by Warren G. Parker and Alisa Carter

A complete index of articles, book reviews, products, Troubleshooting Tips, Symcures and 1986 Profax precedes the directory of Profax that are indexed from their initial publication in October 1982.

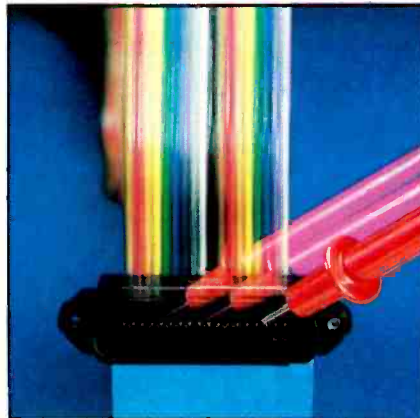

Page 14

Good test tools plus the functional-block approach facilitate TV troubleshooting.

Photo courtesy John Fluke Manufacturing.



Page 39

Super techs simplify servicing with proper maintenance. Photo courtesy Chemtronix.

Departments:

- 6 Editorial
- 8 News
- 10 Technology
- 13 Feedback
- 47 Books
- 48 Troubleshooting Tips
- 56 Computer Corner
- 58 Reader's Exchange
- 60 Products
- 62 Audio Corner
- 64 Literature
- 64 Photofact

39

Troubleshooting audio equipment – Supertech style

By David T. Miga, CET

Be methodical, advises the author, but don't overcomplicate your troubleshooting procedure; simple reasoning will eliminate unnecessary steps.

44

Bug out!

Even intensive care couldn't save one hospital computer after its life was shorted by an \$800,000 roach.

46

Test your electronic knowledge

By Sam Wilson

Ouch!

50

What do you know about electronics?...sawtooth waveforms

By Sam Wilson

Letters from readers inspire a debate as to advantages of sawtooth waveforms in testing, followed by applications of the Hall Effect. Compact discs are introduced.

PROFIT FROM THE MILLION-DOLLAR VCR SERVICE & REPAIR INDUSTRY

VCRfacts™

TECHNICAL SERVICE DOCUMENTATION

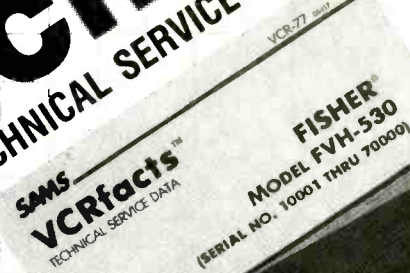

VCR Coverage Includes

FISHER		PV1310	VCR75	VFT193	VCR67
FVH-530		PV1370	VCR70	VFT250	VCR70
(SN 10,001		PV1470	VCR68	VFT450	VCR68
THRU 70,000)	VCR-77 **	PV1500	VCR19	VFT456	VCR68
FVH-520	VCR-78 **	PV1600	VCR36	VFT650	VCR72
FVH-615	VCR-79 **	PV1650	VCR53	VFT854	VCR72
FVH-730	VCR-80 **	PV1750	VCR60	VG7200	VCR74
FVH-530		PV1770	VCR72	VG7203	VCR74
(SN 70,001		PV1780	PF 2340*	VG7205	VCR76
& LATER)	VCR-81 **	PHILCO		VG7207	VCR76
FVH-510	VCR-82 **	V1011	VCR67	VG7225	VCR75
FVH-615	VCR-83 **	V1012	VCR74	VG7650	PF 2375*
FVH-525	VCR-84 **	V1300	VCR39	SANYO	
FVH-715	VCR-85 **	V1001QBK01	VCR76	VR3900	PF 2396 (1)*
FVH-720	VCR-86 **	V1333QBK01	VCR75	VCR3900-11	PF 2396 (1)*
FVH-720R	VCR-87 **	V1441	VCR70	VCR4000	PF 2396 (1)*
FVH-721	VCR-88 **	V1500	VCR45	VCR4000-2	PF 2396 (1)*
FVH-722	VCR-89 **	V1550	PF 2312*	VCR4300	PF 2284*
FVH-725	VCR-90 **	V1551	VCR68	VCR5000	VCR40
GE		QUASAR		VTC9100A	VCR50
1VCR1010W	VCR62	VH5000	VCR8	SEARS	
HITACHI		VH5010	VCR20	564.53030700	VCR13
VT-5000 A	VCR17	VH5011TW	VCR67	564.53040700	VCR13
JC PENNEY		VH5021	VCR74	564.53050800	VCR15
685-5006-00	VCR41	VH5022UW	VCR76	564.53060900	VCR37
685-5007-00	VCR44	VH5030SW	VCR65	564.53180150/151	PF 2284*
685-5018-00	PF 2375**	VH5040SW		564.53110250	PF 2396 (1)*
686-5010400	PF 2312**	(Early Production)	VCR61*	SHARP	
686-5012400	VCR67	VH5040SW	VCR56*	VC6800	VCR52
686-5013400	VCR68	VH5100QW	VCR22	SONY	
686-5020400	VCR75	VH5125UW	VCR75	SL2500	VCR73
686-5021400	VCR76	VH5155RW	VCR46	SL5000	VCR69
JVC		VH5210TW	VCR70	SL5400	VCR27
HR3300U	VCR5	VH5310TW	VCR68	SL5600	VCR33
HR3600AU	VCR21	VH5610TW	VCR72	SL5800	VCR64
HR6700U	VCR49	VH5623UW	PF 2340*	SL7200.A	VCR1
MAGNAYOX		RC		SL8200	VCR7
VH8000	VDP1	PPF600	VCR71	SL8600	VCR10
VH8200BR01	VCR4	SFT100W	VDP2	SYLVANIA	
VJ8220BR01	VCR18	TFP1500	VCR71	VC2210	VCR67
VJ8225BR01	VCR24	TFP1504	VCR71	VC2212	VCR74
VK8222BR01	VCR35	VB7200		VC2700	VCR30
VK8227BR01	VCR47	(Early Production)	VCR2	VC2910	VCR70
VK8229BR01	VCR51	VB7200 (From Serial		VC2215BK01	VCR76
VR8306BK01	VCR76	8033FM001)	VCR9	VC2950BK01	VCR75
VR8315BK01	VCR67	VCT200	VCR9	VC3000	VCR38
VR8316BK01	VCR74	VCT201	VCR16	VC3100	PF 2312*
VR8318BK01	VCR75	VCT300	VCR16	VC3110	VCR68
VR8325BK01	VCR70	VCT310	VCR16	VC3610	VCR72
VR8330BK01	VCR63	VCT400	VCR11	VC3620BK01	PF 2354*
VR8330BK02	VCR58	VD7201	VCR25	TOSHIBA	
VR8335BK01	VCR68	VD7350	VCR23	V5310C	VCR32
VR8345BK01	VCR72	VD7501	VCR28	V5310T	VCR32
VR8346BK01	PF 2354*	VD7555	VCR31	V5420C.T.U	VCR59
PANASONIC		VD7600	VCR34	ZENITH	
PV1000	VCR6	VD7625	VCR43	JR9000P.W	VCR3
PV1100	VCR14	VET180	VCR55	KR9000W	VCR12
PV1200	VCR26	VET250	VCR57	VR8900W	VCR69
PV1265	VCR76	VET253	VCR57	VR9000W	VCR29
PV1270	VCR67	VET450	VCR48	VR9700J	VCR42
PV1275	VCR74	VET650	VCR54	VR9750J	VCR86
		VEP170	VCR71	VR9775PT	VCR73
		VEP174	VCR71		
		VFT190	VCR67		

*PHOTOFAC[®] Format

**VCRfact Format

Manual Format-Specialized Series Manuals

VCR-76 last VCR "Manual" published.

VCR's now covered in PHOTOFAC[®].

*VCR-61 has 2 system control boards.

*VCR-56 has 1 system control board.

(1) March Release

Make Money--Save Time-- Make Repairs Easier

Increase productivity. Accelerate turnaround. Profit with quality, dependable, service documentation from the people who have provided repair data to technicians for over 40 years... Sams.

At \$21.95 each, VCRfacts will more than pay for themselves with a single repair. Less time spent on repairs will increase turnaround time that creates customer loyalty, repeat business, and referrals. VCRfacts can be even more affordable through Sams "Bonus-Buy Plan" for volume discounts.

VCRfacts technical service documentation is available from local electronics distributors, or from Sams. For information about where you can get VCRfacts, call toll-free **800-428-SAMS**.



HOWARD W. SAMS & COMPANY

4300 West 62nd Street
Indianapolis, Indiana 46268 USA

It was so obvious...

Troubleshooting a piece of malfunctioning electronics equipment, especially one as complex as today's television and video equipment, is a challenge. There are so many things that can go wrong, and in many modern direct-coupled sets, a problem that appears to originate in one circuit frequently originates somewhere downstream, reflecting back to the circuit that appears to be the cause of the trouble.

But, as most of you know, that's only the beginning of the problem. In modern sets with start-up and shutdown circuits, the possibilities of the problem source multiply in proportion to about the square of the number of protective circuits. That makes the agony of the problem that much more exquisite.

In spite of this increasing complexity, and its attendant difficulties in troubleshooting, many servicers confess that they feel inadequate if they don't proceed in a straight line direct to the cause of the malfunction. It's a common statement in Troubleshooting Tips and other correspondence that we receive for a servicing technician to conclude, after reciting his approach to a problem, "It was so obvious, I don't know why I didn't think of it first thing."

That's a natural and normal reaction to locating an "obvious" problem cause after spending a lot of time following false trails and turning the problem over and over in your mind. Anyone who has ever spent much time troubleshooting and repairing products has had the same feeling.

But you're being unfair to yourself. Instead of the unalloyed feeling of triumph that you deserve, you feel that you're less than adequate: that you've wasted time and energy following those dead-end leads.

Troubleshooting is a creative process, and like most other creative processes frequently proceeds in a non-linear fashion. A problem in one of today's sophisticated consumer electronic products could be caused by any one of dozens of problems. So you start by saying to yourself "The combination of symptoms consists of A and B and C and D. One cause of that combination of symptoms might be X." When you check out X and that turns out not to be the problem source you think it over a little and you come up with another possibility,

and you check that one.

Let's say that you check that out and it turns out not to be the problem, but an anomaly you discover in checking out that circuit gives you a clue that leads you to suspect another area of the circuit, which you proceed to explore.

Sometimes you get lucky and your first stab at the problem (hypothesis is a more elegant sounding word, by the way) turns out to be the source of the problem. Sometimes you check every possible avenue you can think of and still don't get to the root of the problem. Those are the ones that servicing technicians call *dogs*. Most often, the solution to the problem yields in some reasonable number of steps.

Take a look at a manufacturer's diagnostic chart (if you don't have one handy, there's a partial one in Computer Corner in this issue). Notice that these charts ordinarily have many branches with many steps on each branch. The only way to find the problem source (sometimes sources) is to follow first one branch and then another until you come to the step that points to the solution. And you thought that the answer should have been obvious?

Most people involved in creative work, whether it's engineers, artists or writers, begin the process with some kind of statement of a problem or desired direction, then sit down and proceed to explore all of the possible ways to get to a solution, then choose one or a combination of the possibilities that came to mind. Almost invariably the reaction is the same one that besets the servicing technician when he finds the answer. "It was so obvious." It just *seemed* so after you've spent hours looking at the problem from every angle.

Think about this the next time you diagnose a problem after a lengthy battle and think to yourself, "It's so obvious. I should have been able to go right to the source of the problem. I followed so many false trails." The problem probably wasn't obvious at all. And you weren't following false trails at all, but testing hypotheses. And you probably deserve a pat on the back and that feeling of triumph for solving a tough problem.

Nile Conrad Perren

REACH FOR RELIABILITY



RCA

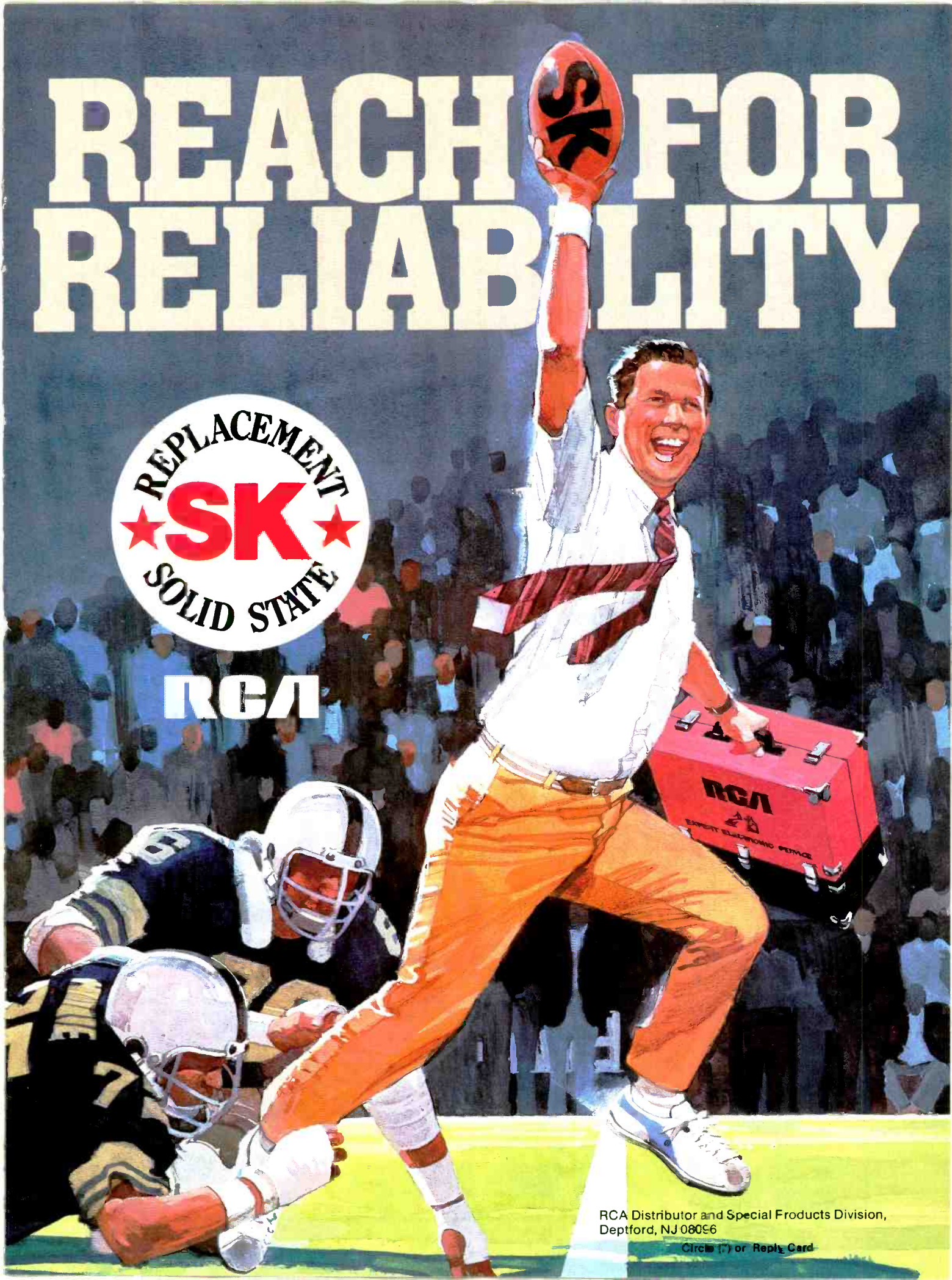

RCA Distributor and Special Products Division,
Deptford, NJ 08056

Circle 7 on Reply Card



VCR-RELATED ACCESSORIES SHARE OF DOLLAR VOLUME — BY STORE TYPE

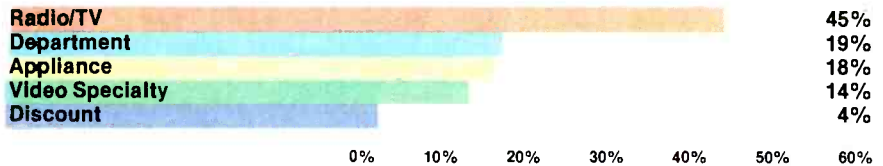

VIDEO CAMERA-RELATED ACCESSORIES SHARE OF DOLLAR VOLUME — BY STORE TYPE

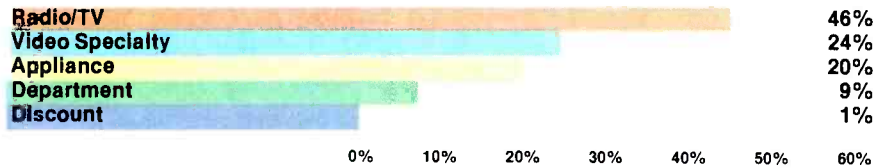

PRODUCT-BY-PRODUCT ANALYSIS SHARE OF DOLLAR VOLUME BY STORE TYPE

VIDEO CARRYING CASES

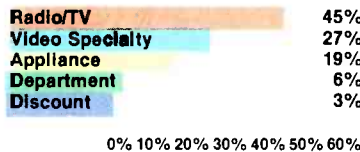

CAMERA TRIPODS

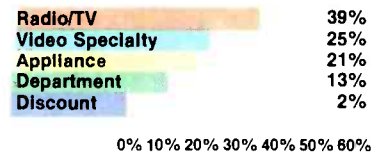

UNIVERSAL LP BATTERIES

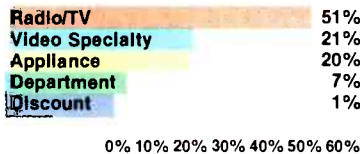

ON-BOARD BATTERIES

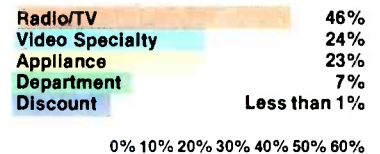

SHARE OF TOTAL DOLLAR SALES BY PRODUCT TYPE

VCR Installation and Maintenance Products	65%
Carrying Cases	10%
Universal LP Batteries	9%
On-Board Batteries	7%
Camera Tripods	6%
Camera Accessories	3%

RCA Distributor and Special Products Division

ELECTRONIC Servicing & Technology

Editorial, advertising and circulation correspondence should be addressed to: P.O. Box 12901, Overland Park, KS 66212-9981 (a suburb of Kansas City, MO); (913) 888-4664.

EDITORIAL

Nils Conrad Persson, *Editor*
 Carl Babcoke, *Consumer Servicing Consultant*
 Dan Torchia, *Group Managing Editor*
 Marjorie Riggan, *Associate Editor*
 Joy Culver, *Editorial Assistant*
 Darryll Fortune, *Editorial Assistant*
 Alisa Carter, *Editorial Assistant*

CONSULTING EDITORS

Homer L. Davidson, *TV Servicing Consultant*
 Christopher H. Fenton, *Circuit Design Consultant*
 Bud Izen, *Computer Servicing Consultant*
 Victor Meeldijk, *Components Consultant*
 Kirk G. Vistain, *Audio Consultant*
 Sam Wilson, *Electronics Theory Consultant*

ART

Kevin Callahan, *Art Director*
 Tim Lynch, *Graphic Designer*

BUSINESS

Cameron Bishop, *Group Vice President*
 Eric Jacobson, *Publisher*
 Greg Garrison, *Sales Manager*
 Stephanie Fagan, *Promotions Manager*
 Kelly Hawthorne, *Marketing Assistant*
 Dee Unger, *Advertising Supervisor*
 Julie Chilson, *Advertising Coordinator*

Regional advertising sales offices are listed in classified pages.

ADMINISTRATION

R. J. Hancock, *President*
 John C. Arnst, *Circulation Director*
 Jo Ann DeSmet, *Circulation Manager*
 Dee Manies, *Reader Correspondent*



Member, Audit Bureau of Circulation



Member, American Business Press



Member, Electronic Servicing Dealers Association

ELECTRONIC SERVICING & TECHNOLOGY (USPS 462-050) (with which is combined *Electronic Technician/Dealer*) is published monthly by Intertec Publishing Corp., 9221 Quivira Road, P.O. Box 12901, Overland Park, KS 66212-9981. Second Class Postage paid at Shawnee Mission, KS 66201. Send Form 3579 to P.O. Box 12952, Overland Park, KS 66212-9981.

ELECTRONIC SERVICING & TECHNOLOGY is the "how-to" magazine for technicians who service consumer electronics equipment. This includes service technicians, field service personnel and avid servicing enthusiasts, who repair and maintain audio, video, computer and other consumer electronics equipment.

SUBSCRIPTION PRICES: one year \$18, two years \$30, three years \$38 in the USA and its possessions. Foreign countries: one year \$22, two years \$34, three years \$44. Single copy price \$2.25; back copies \$3.00. Adjustment necessitated by subscription termination to single copy rate. Allow 6 to 8 weeks delivery for change of address. Allow 6 to 8 weeks for new subscriptions.

PHOTOCOPY RIGHTS: Permission to photocopy for internal or personal use is granted by Intertec Publishing Corp. for libraries and others registered with Copyright Clearance Center (CCC), provided the base fee of \$2 per copy of article is paid directly to CCC, 21 Congress St., Salem, MA 01970. Special requests should be addressed to Eric Jacobson, publisher. ISSN 0278-9922 \$2.00 + 0.00



©1986 All rights reserved.

The End of Aerosol Static Charge Generation

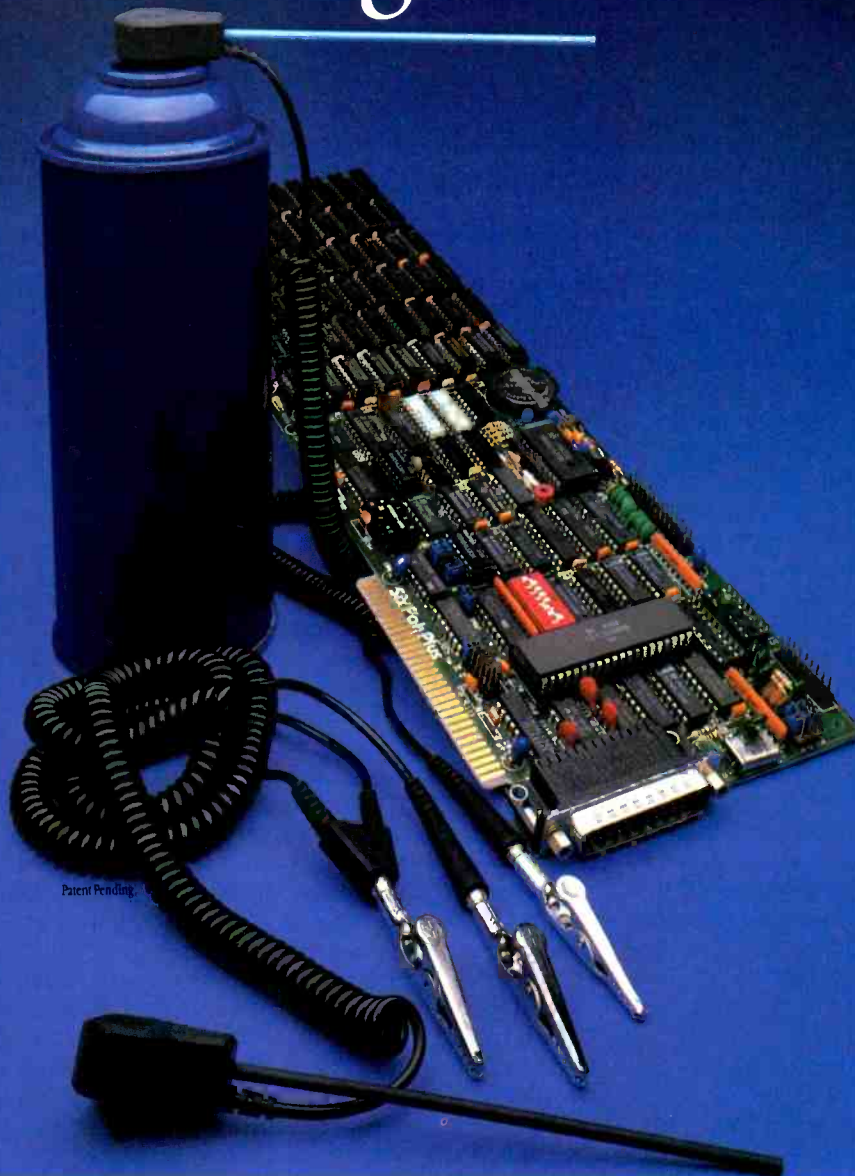

Patent Pending.

Static damage from aerosols has become so serious that aerosols are being banned in an increasing number of facilities. Tests in many facilities show that quick chill sprays and cleaning solvents can generate static charges from 50 to 12,600 volts depending on humidity, spraying time, orifice size and distance between orifice and surface being sprayed.

While adding anti-static compounds to quick chill sprays reduces the charge, they leave minute residues that must be removed or malfunctions may occur. Decreasing orifice size may help but will not end the problem. (Obviously, cleaning solutions for electronic components cannot include anti-static

compounds since all anti-static compounds leave residues.)

AEROGROUND™ The Solid Solution.

AEROGROUND is an equipotential grounding device that replaces the ordinary aerosol delivery system. It includes a concentrically insulated conductive spray nozzle, special sprayhead and appropriate leads that ground the aerosol nozzle/extension to the unit being sprayed. The completed ground loop protects all surfaces as

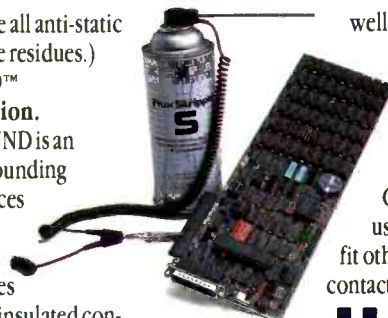

well as the operator from static charge build-up during and following the spraying operation. When properly connected, AEROGROUND specifically controls static charge generation and dissipation from aerosols. (AEROGROUND is designed for the fitments used on Tech Spray aerosols and may not fit other aerosols.) For complete information, contact Don Schrowagen at TECH SPRAY.

TECH SPRAY

P.O. Box 949 • Amarillo, TX 79105 • 806/372-8523
CALL TOLL-FREE 800/858-4043
In Texas: 800/692-4677 • TELEX: 738450
FAX: 806/372-8750

Technology

By Joseph J. Kroger

Science writers love terms that connote mystery. *Artificial intelligence* is one of their favorites. It has a futuristic, Flash Gordon-ish ring to it. And, like most things with an aura of the unknown, it's fun to speculate about.

But now it's time to put some of the more fanciful misconceptions surrounding the topic to rest. Because AI, which can be defined simply as the capability of a machine to mimic intelligent human behavior, is really neither far off nor far out. It's here. And it's beginning to change the way we live.

Case in point—Artificial intelligence technology is making possible a sophisticated type of problem-solving activity called rapid prototyping. This involves simulation that is based so closely on reality that users can visualize real-life implementation. One example of this solution at work: NASA scientists, who had spent eight years trying to eradicate carbon dioxide from space shuttles, turned to AI applications and solved the problem in four weeks.

Case in point—A major U.S. airline has developed an AI application that optimizes seat revenue by analyzing such factors as capacity vs. tickets sold, allocation of full fares and discounted ones, number of days until departure, competitive airlines' seats available, and so forth. For the airline, the benefits are significant, including increased profit, more efficient use of personnel and facilities, and a competitive advantage.

Case in point—An artificial intelligence system called *Just In Time Manufacturing* aims at reducing costs and improving quality on factory production lines by virtually eliminating the need for inventory and storage.

The Just In Time system simulates a factory's entire production



Machines that think! Artificial intelligence—defined as a machine's ability to mimic intelligent human behavior—is a new technology with tremendous potential usefulness. AI's scope encompasses vision, speech, robotics, expert systems (computer programs that incorporate the knowledge of human experts), and natural language.

flow via representations of various workstations and tools that appear in windows on a video screen. It shows not only the functions and relative speed of each tool, but also how much lead time is needed to order parts for each step along the way. And it can suggest ways to correct bottlenecks by moving people and machines around to change the product flow, thus indicating which manufacturing configuration is most productive.

Another AI system being developed takes aim at automating the diagnosis of printed-circuit board failures. The system has already demonstrated its ability to pinpoint faulty devices with a minimal number of probes, while it frees up valuable human resources. The potential dollar savings are dramatic: Conventional testing uses hardware that costs \$1.5 million and is operated by a highly skilled technician, while the AI approach uses a program that costs less than \$100,000 and can be run by someone with two weeks of training.

Still other artificial intelligence systems already in use diagnose diseases, uncover subterranean oil deposits and design computer chips. More such practical applications—many more—are just over the horizon.

Programs like the ones just described are called *expert systems*, so named because they contain the collected, computer-stored knowledge of specialists in a given field; an expert system, when provided with specific information about a

Artificial intelligence: debunking the myths

task, can draw on mountains of data to make a decision based on the stored knowledge about that task. AI's scope also encompasses natural language processing, robotics and vision and speech recognition. At least for the moment, the most promising advances are in the expert systems area.

Essentially, artificial intelligence is viewed as both a basic *technology* (it's a complex software technology, not a *product*) and an exciting *business* with enormous potential.

AI is a new way of using computer technology to solve problems in business and science, boost productivity and improve a company's market position. Those in the forefront of AI technology are poised to offer business and industry a vast array of new tools. Manufacturing, especially, is one area in which AI has many applications, including the technology needed to achieve true computer integrated manufacturing (CIM).

Obviously, any company serious about participating in the AI revolution must commit vast amounts of R&D dollars. But money alone isn't enough. Leadership also requires a willingness to initiate extensive training programs, to increase support for university research projects and to team up with other companies and undertake joint ventures so that products can be delivered in a smooth, timely fashion.

In fact, as AI moves out of the laboratory and into the market-

Joseph J. Kroger is president of Sperry Corporation, Blue Bell, PA, manufacturer and supplier of electronics-based, high technology systems and services. Sperry now has the second-largest installed computer base in the world.

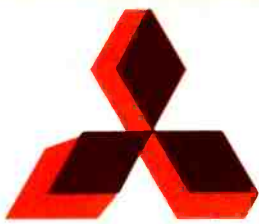

MITSUBISHI NOW OFFERS THE FINEST IN TECHNICAL TRAINING VIDEO AND PUBLICATIONS TO THE GENERAL SERVICING PUBLIC.

VIDEO TRAINING TAPE

- ★ COMPLETE COVERAGE OF THE ALL NEW MITSUBISHI DUAL COLOR TV CHASSIS
- ★ CIRCUIT DESCRIPTIONS
- ★ TROUBLESHOOTING
- ★ INCLUDES TRAINING WORKBOOK



PART # ES-101

\$49⁹⁵



60 MINUTES
VHS ONLY



TECHNICAL MANUALS

FREQUENCY-SYNTHESIZED TUNING SYSTEMS

A Complete Guide to Understanding and Servicing Microprocessor Controlled Tuning Systems. Includes dynamic step-by-step Troubleshooting Procedures adaptable to most PLL Systems.

PART # ES-FS

\$14^{95*}

- ★ EXCELLENT REFERENCE VOLUMES
- ★ FULLY ILLUSTRATED
- ★ WRITTEN EXPRESSLY FOR THE SERVICE TECHNICIAN

PROJECTION TELEVISION

From a leader in the Projection Television Industry, this unique volume explains the Principles of Projection Television. Includes discussions of Optics, the Why and How of Convergence, much more.

PART # ES-VSS

\$14^{95*}

COMPACT DISC AUDIO

Coverage of the Mitsubishi DP-103 CD Player includes the Basics of Digital Audio and CD Players . . . Recording, Playback Principles, Laser Pick-Ups, and more.

PART # ES/DP103

\$14^{95*}

VHS Hi-Fi

Analysis of the Mitsubishi HS-400UR VCR explains the Principles of Broadcast Stereo and VHS Hi-Fi, recording and playback techniques.

PART # ES-HS400

\$14^{95*}

*TO PLACE YOUR ORDER, CALL TOLL-FREE (800) 421-1099 CA ONLY (800) 262-1341
(COD ORDERS ACCEPTED)

SHIPPING AND HANDLING EXTRA

FOR A COMPLETE LIST OF AVAILABLE MITSUBISHI TECHNICAL MANUALS AND VIDEO TAPES, CONTACT:

MITSUBISHI ELECTRIC SALES AMERICA, INC.
TECHNICAL SERVICES-DEPARTMENT EST
P.O. BOX 6007
5757 PLAZA DRIVE
CYPRESS, CA 90630-0007

Circle (9) on Reply Card

Continued from page 10

place, its true nature becomes increasingly apparent. Basically, it's nothing more than sophisticated electronic circuitry rigged up to manipulate symbols in the same way that people do when they rea-

son through problems and come up with feasible solutions.

Solving problems that until now were beyond the computer's grasp: *That's the name of the game.* And we're starting to win it.

World's fastest transistor

Toshiba researchers have developed a hetero-junction bipolar transistor (HBT)—a new generation transistor—with the world's fastest switching time per gate of 35ps (a trillionth of a second).

An HBT is a high-speed transistor of the future that uses compound semiconductor materials of aluminum gallium arsenide (AlGaAs) and gallium arsenide (GaAs). Numerous applications are expected in such fields as central processing units (CPUs) for next-generation supercomputers, and transceivers designed for optical communications.

In order to fabricate an integrated circuit using HBTs, research focuses on the miniaturization of each transistor. The key to making each transistor smaller is to shrink the gap between the electrodes of the emitter and the base while retaining sufficient insulation.

However, in the conventional method, the emitter and the base (key elements forming a transistor) are formed respectively by using different masks, which means extra space is needed to ensure enough isolation between each electrode. This increases the overall size of the transistor.

Toshiba researchers have overcome this problem by developing a completely new process technology called the *self-alignment* method. In the new method (see Figure 1), the emitter is first formed and then a new thin layer of silicon dioxide (SiO_2) is introduced as an insulator to cover the emitter region completely. Then the base electrodes are formed next to this SiO_2 layer, which means that no extra idle space is required to complete the new transistor.

In other words, experimental results show that the width of the emitter thus has been halved from 4μ to 2μ , and the gap between the emitter and the base electrode re-

duced to one-fourth: from 1 down to 0.25μ . As a result, the size of the whole transistor has been reduced significantly.

At the same time, the ion implantation technology has been improved for making the external base region. In the conventional method, only magnesium is implanted. Toshiba researchers have found that adding some phosphor along with magnesium virtually will suppress lateral diffusion, or erosion of magnesium into the emitter region.

By using these two key technologies, Toshiba has test-manufactured a CML (current mode logic) ring oscillator—a typical device for measuring the speed of a transistor—integrating 97 pieces of

HBTs. The oscillator recorded the world's fastest switching time of 35ps per gate, more than 5ps faster than any other kind of bipolar transistor device.

Several new types of transistors are now being developed, including MESFET (metal-semiconductor field effect transistor), HEMT (high electron mobility transistor), Josephson Junction devices and HBTs.

HBTs have the advantage that, unlike Josephson devices, they are capable of operating under normal environmental conditions. Further, unlike MESFET and HEMT, HBT is a kind of bipolar transistor whose current capability is superior to FETs and that is more suitable for very high speed ICs. **ES&T**

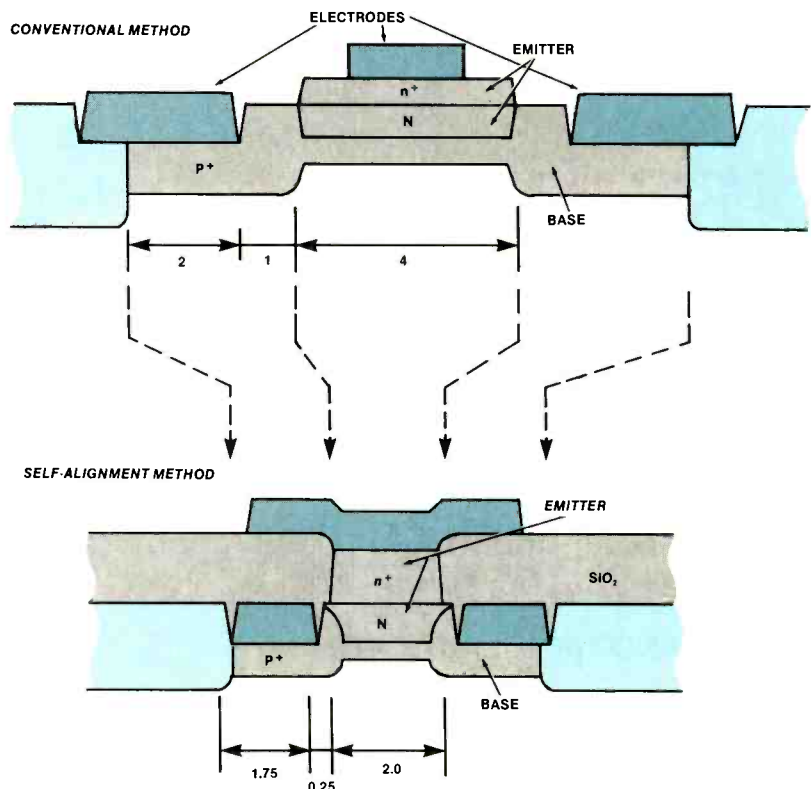

Figure 1. The self-alignment method of transistor fabrication eliminates wasted space, resulting in a smaller device.

Feedback

Letter to Sam Wilson

I would first like to congratulate you on your fine articles for *Electronic Servicing and Technology*. As chief engineer for the University of Massachusetts, Video Instructional Program, I keep myself up with almost all the video/electronic technology magazines and periodicals. I find *Electronic Servicing and Technology* to be the finest among a very large group.

The Video Instructional Program transmits electronic engineering classes via Ku-band satellite to industry to allow engineers in the field to access graduate studies, and earn graduation degrees while in their own work place. As an integral part of the university's College of Engineering, I spend a lot of time among prospective engineers just learning their trade, and feel that it is very important that they get off on the right foot. I appreciate your continual discussions and observance of proper safety procedures, and want to express some thoughts on that subject.

I recently found myself in our vast library searching through various technical materials when I came across a book in which the author is discussing the correct use of meters. A quote reads *The two-hand method is a dangerous practice which should be avoided religiously*. Obviously this is marvelous advice, but ironically the protective jacket of this very book shows a photograph of a technician using the *two-hand method* while testing an electronic device! This seems to be a dramatic oversight considering the author spends a great deal of time concentrating on proper safety procedures.

I have known many technicians who have held solder in their mouths while soldering, and have used other improper or unsafe methods of testing or repair. Many periodicals focus on new equipment, software or practices in our field. I'm as enthusiastic as anyone

about new information such as this, but I feel that I should applaud you in taking the time to remind everyone that safety is first, and should never be taken for granted. If there is anything I would like to share with the new engineers graduating from the University of Massachusetts, or anywhere else, it's the concerned reminder to always observe careful and safe technical procedures. Thanks for doing your share of the same.

Andrew R. Casiello, MT
University of Massachusetts
at Amherst

I want to thank you very much for your letter regarding safety practices and also for your comments on my material in ES&T magazine.

You are quite right to be concerned about the safety aspects of electronics. It is very often overlooked in our haste to keep up with the technology. In the near future I expect to discuss some dangerous chemicals—such as tantalum—that are being used in manufacturing today. In addition to the safety of technicians, there is the problem of discarding these chemicals into the environment. (I guess you could say that is an indirect safety problem.)

Sam Wilson

Letter to Sam Wilson

I wish to apply for one of your rare and valuable certificates as described in your article in the September issue of *Electronic Servicing and Technology*. I take some exception to the answer to question 3 on page 71. Because Black, Nyquist and Bode, who invented and formulated negative feedback, were all friends and associates of mine, I feel some responsibility to respond. Also, of my 59 issued U.S. patents, several apply to negative feedback.

Black's patents in 1925 and 1932 and Bode's 1940 article in the Bell System Technical Journal, "Relations Between Attenuation and Phase in Feedback Amplifier Design," together with Nyquist's stability criteria, paraphrased "Thou shalt not enclose the point on the complex plane, $1+J0$," are the authorities I cite.

The *amplifier gain* is not what a

Bode plot presents nor is it what Nyquist described in his stability criteria. Bode and Nyquist were talking about the loop gain of feedback amplifiers. Further, the Bode plot is not a simple graph but is a plot on the complex plane. The X axis is real numbers and the Y axis is imaginary numbers. Mu beta is plotted, not *amplifier gain*. A feedback amplifier with a forward gain of mu and a feedback gain (loss) of beta will have an external gain, *amplifier gain*, of mu divided by 1 plus mu beta. This external gain is generally far different from the loop gain. The measurement of external gain is of little value in determining feedback stability or distortion reduction by feedback, which were major concerns of all three gentlemen cited.

If I do earn one of your rare and valuable certificates, or perhaps even the first one, I promise to hang it on the wall of my laboratory. Although retired, I keep busy. Habits from over 40 years at Bell Labs are hard to break.

Ray Ketchledge
Englewood, FL

Thank you for your interesting and informative letter regarding the origins of the Bode plot.

Regardless of the original intent of the authors, the term Bode Plot has now come to mean a plot of gain and phase angle against frequency. I now quote directly from the IEEE Standard Dictionary of Electrical and Electronics Terms (IEE Standard 100):

Bode Diagram

A plot of log-gain and phase-angle values on a log-frequency base for an element transfer function, a loop transfer function, or an output transfer function....The ordinate may be expressed as a gain, a log gain, or in decibels as 20 times log-gain; the abscissa as cycles per unit time, radians per unit time, or as the ratio of frequency to an arbitrary reference frequency.

So, regardless of the original intent, Bode plot has come to mean a plot of gain and phase angle values against frequency.

Keep trying. I am sure the highly coveted certificate is well within your grasp judging by your letter of August 28. Maybe next time!

Sam Wilson

TV troubleshooting hints and tips

By Conrad Persson

Troubleshooting a television is one of the hardest things in the world to do. OK, there are probably a few things that are harder: housebreaking a grizzly bear, going over Niagara falls in a teacup, winning the Indianapolis 500 on a skateboard. But a malfunctioning television does present strenuous challenge to someone bent on diagnosing and repairing the problem.

There are several things that the service technician can do, however, that will help to reduce the difficulties of servicing a television to manageable proportions:

- Observe symptoms carefully, in detail, and make a note of them.
- Keep in mind the television's functional blocks.
- Know and apply some of the long-established TV troubleshooting hints and tips.

Ask questions

Have you ever observed carefully what your doctor does when he's examining you? He goes through a set routine of tests and measurements: temperature, blood pressure, pulse rate, heart and lung sounds, reflex, and more, and carefully notes them down. At the same time he's asking you if it

hurts anywhere or if you're experiencing any other symptoms, and noting that down as well. It all becomes part of your record.

This orderly approach to noting symptoms is no less valuable in treating sick televisions than it is in treating sick people, and even in the most obvious cases should be followed. When you're planning to work on a television, you should ask the principal viewer questions that will help pinpoint where the trouble lies. Ask questions such as:

- Describe the exact nature of the problem.
- Was this a gradual decline in performance or did it occur suddenly?
- How long has the problem existed?
- Are there any other symptoms?
- Have you moved the set recently, or made any other changes in the viewing room?
- Have you had problems with any other electronic devices?
- Has there been an electrical storm in the area recently?

The answers to questions like these may not by themselves lead to a diagnosis of the problem, but can help point to the answer. Gradual onset of a problem sug-

gests aging of components, but sudden failure points to something catastrophic that might be observable as a burned component or some other visible problem. If the problem had a sudden start and occurred at about the time of a thunderstorm, your subsequent investigation might include close scrutiny of the television's circuits for evidence of lightning damage.

Observe symptoms

As soon as you get the malfunctioning set on the bench, the next step is to turn it *on* and observe symptoms for yourself. Again, don't forget to make note of anything unusual. If the set operates normally, and your earlier investigations led you to suspect heat related problems, you might use a heat lamp, or cover the set with a blanket or something similar to accelerate warming the set to the point where it malfunctions.

Look. Listen. Smell. When you first turn the set *on*, you should hear the rushing sound of the high voltage coming up. Note the picture: Is the size correct, brightness, color? How's the sound from the speaker? Are there any unusual smells, such as might be caused by an excessively hot component? If this television does exhibit intermittent problems, if you

don't write notes about proper operation and problems noted, by the time it does malfunction, you'll have forgotten what you've observed. Take notes.

When you have the set opened up, again use all your senses and make notes of your observations. Use your eyes: Check for loose wires, blackened components that are evidence of excessive temperatures caused by overloading. Examine components for signs of cracking; of other problems, such as leakage of electrolyte from capacitors. If a component doesn't look right, there's a high likelihood that it's bad. Check it carefully and replace it if it's bad.

Component temperature is another indicator of whether the circuits are operating properly or not. If you suspect a certain component, sometimes a finger care-

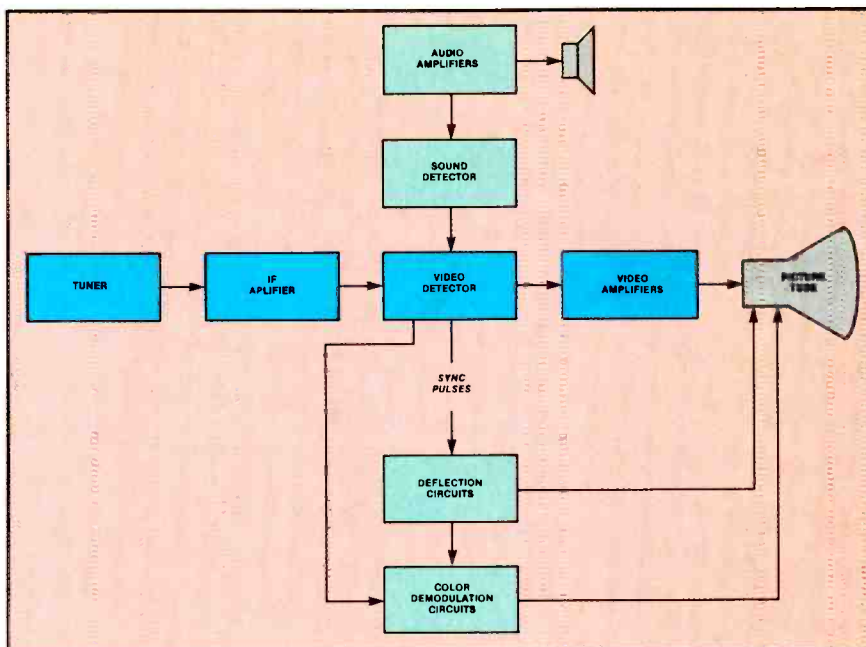

Figure 1. Thinking of a television or other consumer electronics device in terms of its functional blocks, and evaluating the trouble symptoms in those terms, can help isolate the source of the problem.

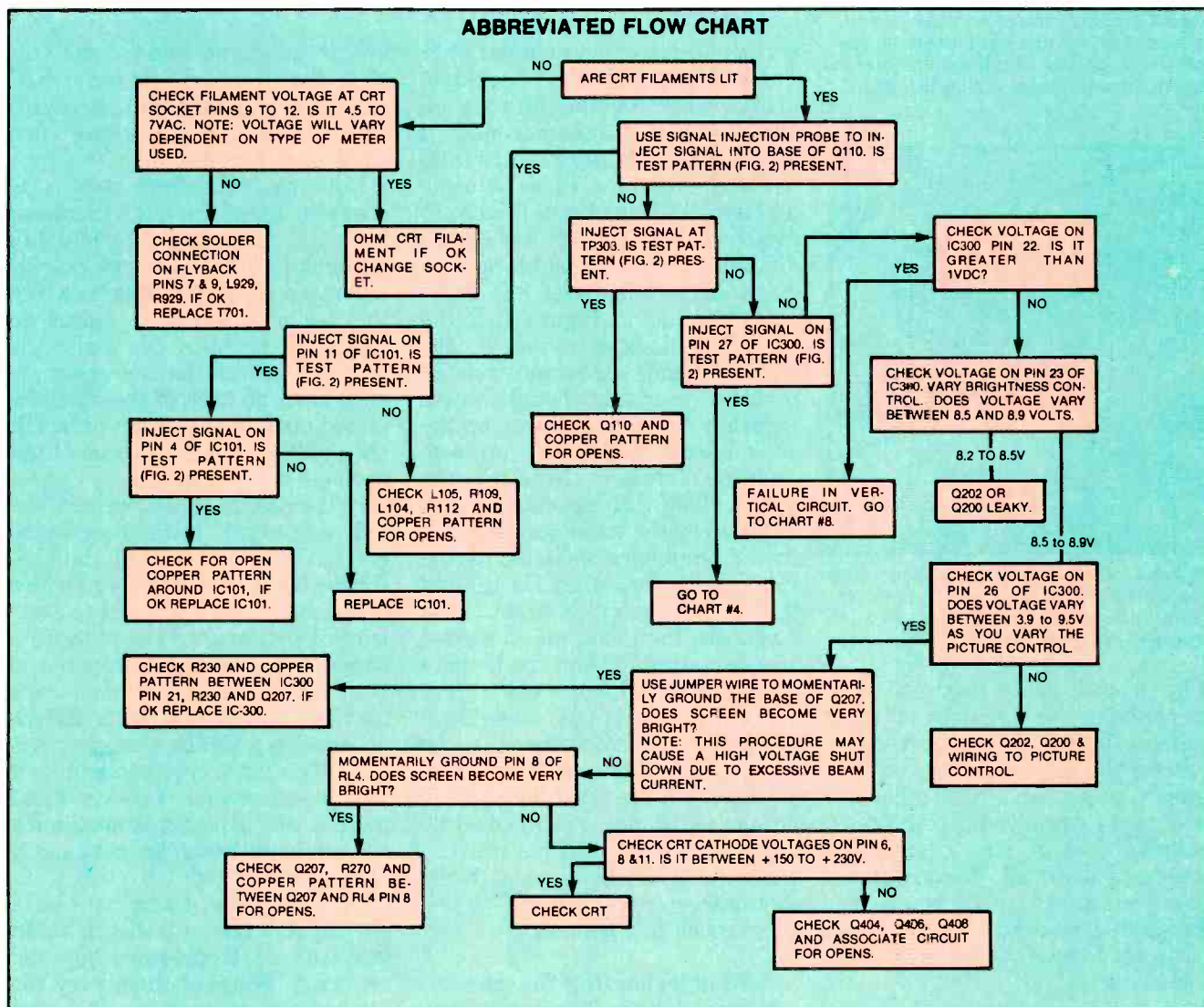

Figure 2. Manufacturers' troubleshooting flowcharts, such as this one from GE, are an aid in logical, step-by-step, fault diagnosis. A technician who is familiar with the functional block description of television can, with the aid of the schematic diagram (Figure 3, page 16), establish a similar troubleshooting approach. (Drawing and chart courtesy of GE Company.)

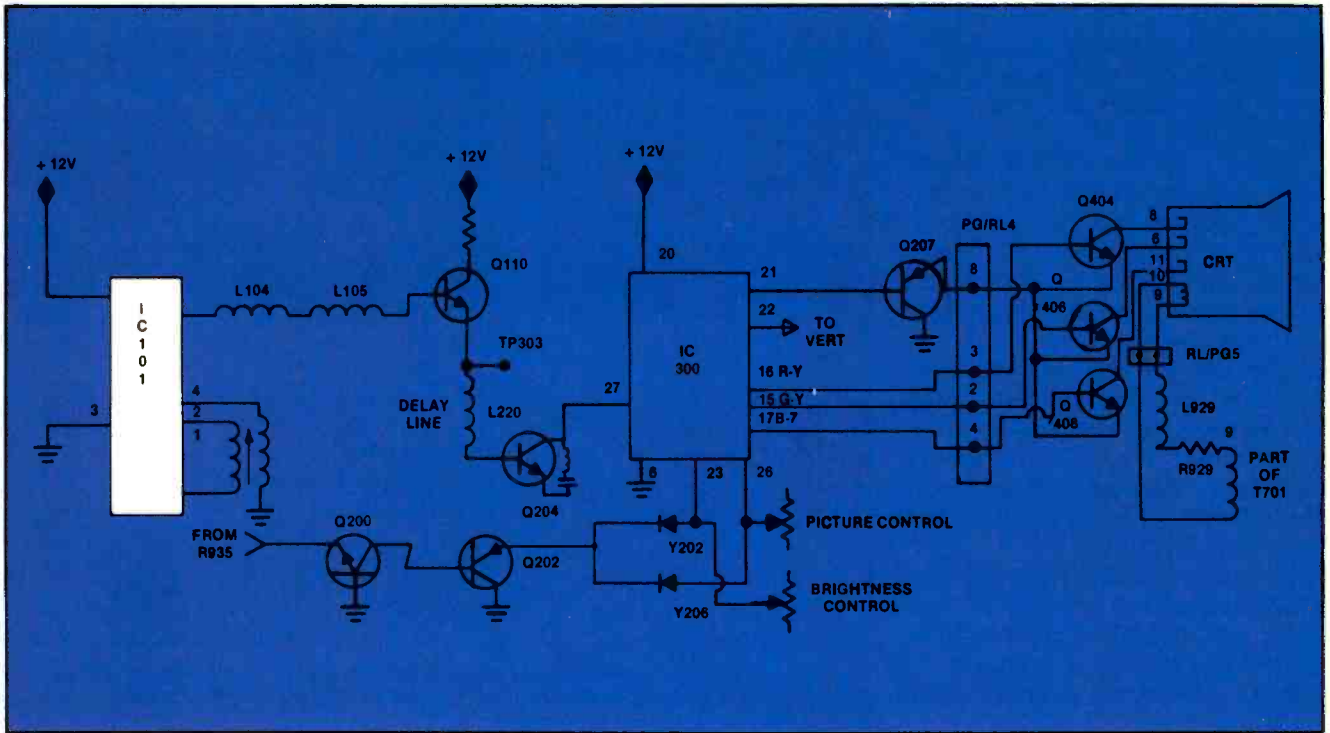

Figure 3. Symptoms of *no video, no color, audio ok*, narrow troubleshooting effort to this portion of television. Refer to Figure 2 for troubleshooting flowchart.



Figure 4. Alternately heating and cooling suspected components can help to pinpoint the cause of failure. (Photo courtesy of Chemtronics)

fully placed on it (with all due precautions for hazards of high voltage, burns, etc., observed, of course) will tell a great deal about what's going on. A component that's very warm to the touch may indicate a short circuit or other source of overload. A component that you expect to be warm but that is cold, on the other hand, suggests that there's an open circuit somewhere.

Remember functional blocks

A glance at the schematic of a modern, sophisticated TV set

reveals an extremely complex unit. There are hundreds of components, wired together in very intricate fashion. Sometimes it seems as though any of those little devils could be the cause of some problem. At those times it helps to remember that any TV set can be divided into functional blocks and diagnosed on that basis. For example, referring to Figure 1, if the problem is lack of sound, or distorted sound, or some related problem, your first thought would naturally be to concentrate on the audio circuits. But the problem could be elsewhere. Note that the sound, along with the video, has to be tuned by the tuner, amplified by the IF amplifiers, detected by the video detector, then is routed through the sound circuits. Your diagnosis, then, becomes a matter of considering likelihoods. If there is a problem with the sound, but everything else is OK, most likely the problem is somewhere on the audio circuit side of the video detector. On the other hand, if the problem is audio, accompanied by some degeneration in the video as well, the problem is most likely somewhere from the video detector on back to the tuner.

A troubleshooting flowchart

Figure 2 is a flowchart taken from GE's troubleshooting guide for the PC chassis. It suggests a course of action if the symptoms

are no video, no color, audio OK. Note that it doesn't go beyond IC 101. If the audio is OK, it means that everything's working fine right up to that point.

Note that the first step is to check to see if the CRT filaments are lit. The troubleshooting thought process has very quickly narrowed down the area in which the technician has to search to locate the problem. Note also the continuation of the flowchart. In each case, an area of the circuit is tested, and if it turns out to be OK the next most likely source of the problem is considered.

In the case of this flowchart, the GE engineers have been kind enough to do most of the thinking for the technician, but if you take a functional block approach to servicing televisions, or any other consumer electronic product, you can, with the aid of the manufacturer's service literature or Sams material, develop a similar thought process: "If *only* A is malfunctioning, it must be somewhere between x and y. If A *and* B are malfunctioning the problem *must* be between y and z," and so on.

Over the years, technicians have developed a bag of tricks to aid in the task of troubleshooting and servicing. Some of them vary the voltage or current to the unit under test, some of them change the temperature of the devices that are suspected, but they *all* im-

Continued on page 18

★ **RESEARCH**

★ **DEVELOPMENT**

★ **PROTOTYPING**

★ **PRODUCTION**

Diehl Industries of Amarillo, Texas proudly announces the opening of a new and unique research, development, and proto typing division, for use by the nation's electronic industry.

WHAT MAKES IT SO UNIQUE

Traditionally, when a company or an individual has a new idea, mass confusion sets in, - - - and promptly takes control of the project.

The "electronics" for the original idea goes one direction (to R & D), while another "team" scrambles to develop the mechanicals for the case that will house the final product.

From "R & D" the artwork for PC boards must be generated, then sent to a PC board manufacturer, the mechanicals for the case must then be sent to a plastics manufacturer, once they are finished, the PC boards must then be sent to a "board stuffing" company, someone must then find the best price on component parts and hardware, someone else must coordinate the receiving of same, while yet another team s frantically trying to develop an operations manual for the final product (which must then be sent to a printer, who will ultimately have to send it out to a bindery to be bound, and turned into an actual book).

You guessed it! By the time all of the above comes back to home base, - - - nothing fits ★!↘\$*

(just ask anyone who has tried it).

Diehl's new division has a unique advantage over tradition, in that all of the above is done under one roof.

Diehl's R&D Department can take a preliminary schematic (or just an idea without the schematic), design it, or refine it, bread board it,

test it, turn it into working artwork for printed circuit production, then, using their own proto typing system, produce the original "trial" PC boards. Our R&D staff has immediate access to four, totally separate individual, full time, "in house" CAD systems (computer assisted design). In a "total design" project all four will become necessary.

"Auto CAD 86" will be used to generate shop drawings which will then be used by Diehl's Plastic Division.

Winteks "Hi-wire" will be used to generate the necessary schematics for use by Diehl's own in-house printing and bindery department along with the necessary text for same, which will be provided by Diehl's in-house technical writing staff.

Winteks "smart-work" will be used to generate artwork to produce PC boards. This same artwork is then given to Diehl's in-house camera and stripping dept. where it will be photographically reduced, and turned into working transparent positives, which will then be given to Diehl's in-house PC manufacturing division (once the R&D proto type boards have been approved).

Meanwhile, Winteks "drill" CAD System is used to generate the necessary "drilling" information for our Excellon "Mark III", four spindle, computerized drill which is just part of Diehls in-house PC board manufacturing division. Once our Excellon drill (which is based on an 8,000 lb. granite slab for accuracy) has completed the drilling operation (at 10,000 holes per hour × 12 boards at a time), the boards will go through our own in-house chemistry, then into one or more of

our fourteen in-house electro platers for copper, tin-lead, nickel, or gold.

After being properly sized, the PC boards will then go to our in-house "board stuffing" department (which employs 20 full time stuffers). There it will be "stuffed", wave soldered, inspected, tested, then given to quality control for final inspection.

Meanwhile: Our purchasing dept. has been on the phone with every major supplier in the country fighting for the best possible price on the highest quality components. Our in-house printing and bindery division has produced the operation manuals from artwork that was provided by our own technical staff. Our in-house plastics division (which does some of the most sophisticated vacuum forming in the nation) has produced the cases into which the final product will be assembled. Our own in-house silk screening department has produced all necessary escutcheon plates and panels.

All of the necessary components are now ready for mass production by our own final assembly division. Because everything was done under one roof, and monitored by one project supervisor, - - - everything fits!

In addition to the above, we also have our own in-house advertising agency and international marketing facilities.

The next time you have a "project" think about us, - - - **we can make it happen!**

DIEHL INDUSTRIES

6661 Canyon Dr.
Amarillo Texas 79110
Phone (806) 359-0329

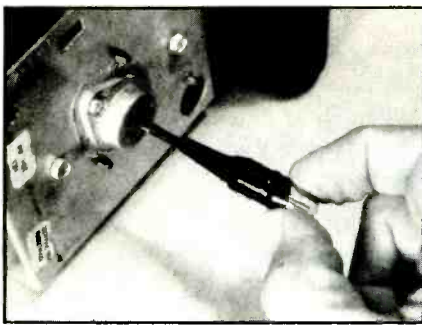

Figure 5. A neon bulb can verify the presence or absence of horizontal sweep pulses.

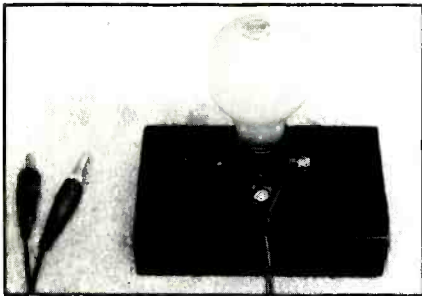

Figure 6. A 100W light bulb placed in series with a portion of a TV circuit that's drawing excessive current and blowing fuses or popping the breaker will limit the current to give you time to troubleshoot the set. The degree of brightness of the bulb will give you an indication of the severity of the overload.

prove your chances of determining what the problem is.

Heating and cooling components

One way to pinpoint which device in a circuit is causing problems is to alternately heat and cool each device in the circuit in turn. Frequently, a heat rise causes a defective transistor, IC or diode to stop operating. If a circuit in a set on the bench no longer operates properly after warmup even though the set behaved properly while it was comparatively cool, a short blast of canned coolant spray on the suspect component might restore operation (see Figure 3). If so, you can be fairly confident that replacing the component will solve the problem. To double check, you might add heat with a hair dryer or other heating device to see if the problem comes back.

Checking for sweep with a neon bulb

A neon bulb will glow when brought into close proximity to a source of high voltage. You can use this fact to check to see if there is sweep. Solder a well-insulated piece of short heavy wire to one

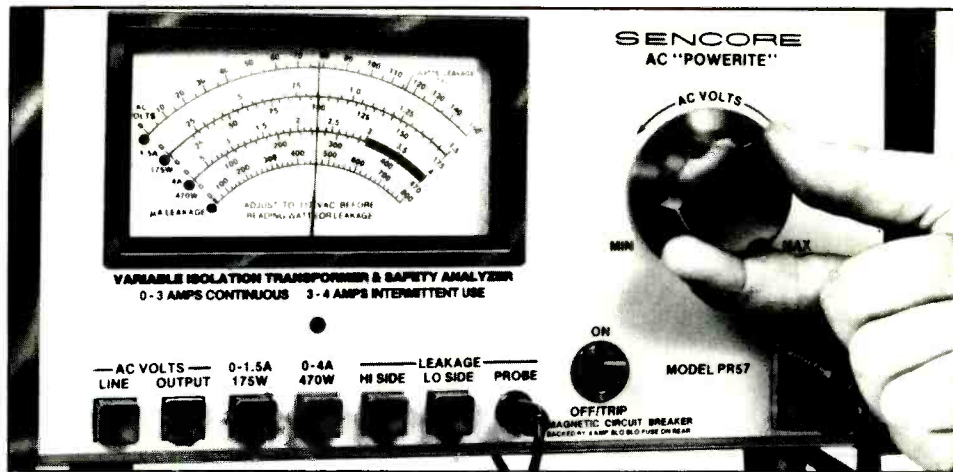

Figure 7. A variable voltage power supply is another way to limit the current to a faulty television. A unit such as this model PR-57 Powerite by Sencore has the additional advantages of measuring wattage, performing leakage safety checks and providing isolated power.

terminal of a neon bulb, then tape the connection, the wire and the metal part of the bulb with plenty of electrical tape.

To test for the presence of horizontal output pulses, hold the bulb in your fingers and bring the wire near the flyback or touch it to the horizontal output transistor's collector. Touch only the glass part of the bulb. Do not touch the wire to the high-voltage pulse output from the flyback; the danger of arcs and shock are too high to try this.

Limiting the current with a light bulb

If you're faced with a set that has such a serious short or other overload producing fault that the fuse blows every time you turn it on, or it goes into shutdown, you need some way to limit the current. A very inexpensive way to limit the current into such a set is to replace the line fuse with a 100W light bulb, the same kind you put into your living-room lamp. One way to go about this is to use a socket like the one shown in Figure 5, and just clip the alligator clips onto the fuse clips. With the light bulb in circuit, the current will be limited and allow the set to operate while you proceed with your diagnosis. An added advantage is that the brightness of the bulb will give you an indication of the severity of the overload. A dim bulb means only a slight overload, while a bright bulb might mean almost a dead short. The bulb also can be used to limit the current in any high-current circuit that is exhibiting a near short

circuit. For example, if a color television has a fuse protecting the horizontal-output transistor and that fuse blows instantaneously each time the set is turned on, the bulb should be connected across that fuse holder in place to the fuse. If the bulb lights up to nearly full brightness, you know that there is excessive current. You then disconnect the tripler, damper, horizontal-output transistor and other prime suspects one at a time until the bulb becomes significantly less bright. That part is the prime suspect.

Varying the line voltage

Another way to keep a television with a probable overload from blowing fuses while you're trying to troubleshoot it is to use a variable-voltage power supply. The reduced voltage may allow you to operate the set long enough to isolate the problem.

It's as easy as one, two, three

Locating and correcting a malfunction in one of today's sophisticated color televisions is a challenge; but an orderly, logical approach to the problem can prevail. Gather as much information as you can, from the set's primary viewer as well as your own observations, apply that information to the set, looking at it in terms of its functional blocks, and apply some of the tricks. You probably will find that these steps, along with judicious use of instruments like a DMM, oscilloscope, signal generator, etc., will lead to solving most TV problems.

ES&T

WANTED

TV TECHNICIANS

Diehl Industries is looking for about thirty competent, well seasoned, TV technicians who are good at repairing TV sets but somewhat tired of the everyday "Rat Race" that goes with it.

Specifically, we are looking for some thirty salaried (plus commission) area sales reps to call on TV service shops, schools, colleges, major industries, and military installations, to sell test equipment and other services.

These positions require five day a week travel with anticipated annual earnings of about \$70,000⁰⁰ for anyone who is willing to work at it.

After a thirty day trial period company vehicles are available as is a weekend "fly home" expense account.

A pleasing, outgoing personality, a good working knowledge of the TV service industry, and a strong technical background will get the job done, --- our products sell themselves!

In Case You Don't Believe It

Anyone who fits the above description is well aware of the fact that late model start up and shut down circuits are making it all but impossible for most shop owners to earn a living. If not, they are certainly "absorbing" most of his time, and much of his normal profits.

One of our products is a diagnostic computer called the Mark VII-E Eliminator. The Mark VII-E will (at the push of just one single button), identify the exact, specific, defective component that has caused any type of "dead set" or start up / shut down symptom, i.e. in the power supply, the LV regulator, horiz output, damper diode, safety capacitor, yoke, pin cushion transformer, discharge (return) capacitor, centering diode, horiz osc/driver, any type of start up or shut down circuit, the flyback,

HV multiplier, any scan derived B+ source (the specific leg), or any short in any circuit that is connected to any scan B+ source.

In addition, the Mark VII-E will instantly tell you whether the defective component is open or shorted, as well as tell you exactly how the defective component has affected the performance of the overall LV/HV circuit. (i.e. Did it cause the horiz osc/driver to go into shut down, cause LV regulator shut down, kill the start up pulse, create an inductive short in the flyback circuit, etc.).

Whats more, the Mark VII-E will also automatically give you a "landmark" test point to measure so that you can verify that its findings are 100% accurate. (i.e. It might tell you to measure the collector of any R-B-G output transistor for a minimum of +150 volts. If that voltage is not present, the computer's decision is 100% accurate).

As far as locating the exact, specific "leg" of the circuit that has failed, the Mark VII-E never misses. In cases where several components on that same "leg" could cause the same condition (i.e. an open or a short), the Mark VII-E will automatically calculate the "odds of probability" then give you the most likely to fail component first. If that component checks ok, the next time you push the test button it will automatically give you the next most likely suspect.

For the sake of example: Let's say the Mark VII-E has determined that the scan B+ leg for the horiz osc/driver is open. The Mark VII-E sees the open, but may not know why it is open.

Further, lets say that this "leg" has two series resistors in it (R1 and R2). The Mark VII-E will calculate the odds for both resistors then light the one that's most probable to fail (R-1). If that resistor is ok, the next

time you push the test button it will light R-2. If R-2 is ok, the next time you push the test button, the Mark VII-E will tell you that an open solder joint exists between R-1 and R-2.

The Mark VII-E may not know why that particular leg is open, but it knows for **absolute certain** that it is. Once that is established, it then knows how to isolate the exact, specific, component that has failed.

Add to the above, the fact that the Mark VII-E can isolate intermittants while the technician is out picking up parts, and it doesn't take a "mental giant" to figure out why we are looking for thirty salesmen.

For years the TV service industry has been looking for a magic wand, --- we have exactly that. The problem is, the Mark VII-E is so incredibly fast, accurate, and effortless (a freshman electronics student can operate it), most shop owners just can't believe it until they have seen it. Then, when you tell them that it does all of the above in just one/one hundredth of one second, at the push of just one button, and that it requires no "hunt and peck" probe to work, and no computer experience whatever, --- they **really** can't believe it!!

The fact is: it doesn't matter whether or not they want a Mark VII-E, once they see one in operation, --- they will have to have one!!

The Mark VII-E is just one of our products. Everything we do is innovative.

If you think you have what it takes to be a sales rep., we'd like to talk to you.

DIEHL INDUSTRIES

6561 Canyon Dr.
Amarillo, Texas 79110
Phone (806) 359-0329

Watch Your Language

By Conrad Persson

Every major advancement in electronics entails new materials, new manufacturing techniques and new packaging. All of this introduces new concepts to be learned and new terms for the vocabulary.

Many of us got involved in electronics during the era of the vacuum tube, and terms like plate, cathode and grid are an integral part of the language we command (even if we rarely use those terms any more).

The transition to transistors reduced the size and power consumption of consumer electronic products, ushered in the era of truly portable radios, and swelled the vocabulary with terms like emitter, collector, base, bias, TO-5 and other solid-state terms.

More recently, integrated circuits were introduced, and a flood of new terms came into the language: DIP, SIP, thin film, thick film, hybrid IC, monolithic IC, and more. Unfortunately, much of this new terminology was thrown about by those in the know with little or no explanation. Many of the terms are still poorly understood or not generally understood at all.

From time to time when room permits, beginning with this issue, we'll feature a few detailed explanations of some of the less well understood terms.

Thick vs. thin films

When someone first showed me a hybrid integrated circuit that featured *thick-film* resistors and conductors, I thought they must be mistaken; the films I saw looked thin enough to me. And they were thin. But in the crazy subminiature world of integrated circuits, anything thicker than 0.001mm (yes, one thousandth of a millimeter) is a thick film.

Besides this gross thickness, two other features generally characterize thick films: They are ordinarily deposited as inks or pastes (some kind of liquid vehicle containing either a highly conductive metal or a resistive material like carbon) using a silk screen process, then baked to set the material and trimmed using a sandblasting type process. They are generally used in hybrid integrated circuits and are laid down on the same substrate with the components that they interconnect.

Thin film circuits, on the other hand, consist of material less than 0.001mm thick, deposited on a ceramic or silicon substrate via evaporation or sputtering through a mask (a kind of stencil for IC work). Thin films are ordinarily of metal or metal compound. One typical thin film fabrication process consists of placing the masked substrate into a chamber filled

with nitrogen. Tantalum, a hard metal, is bombarded with an electron beam (sputtered), enters the nitrogen atmosphere, combines to form tantalum nitride that is deposited onto the substrate through the mask, defining the pattern.

What's a substrate?

The foregoing definitions included the term *substrate*, which is frequently not defined and may not be well understood. The substrate is merely the material on which a circuit or a portion of a circuit is fabricated. Its purpose is mainly to provide mechanical support for the circuit components. There may in fact be more than one substrate mounted one on the other. For example, the silicon or other material on which a thin-film resistor network is sputtered or evaporated is the substrate for that network. If the resistor network is going to become part of an integrated circuit, it may be mounted onto the integrated-circuit substrate. I suppose a case could be made that the PC board is the substrate of the completed circuit.

Sheet resistivity

Sometimes when you see discussions of thin-film devices or material, you may see the term P_s , *sheet resistivity*, and see it given as so many ohms per square. The

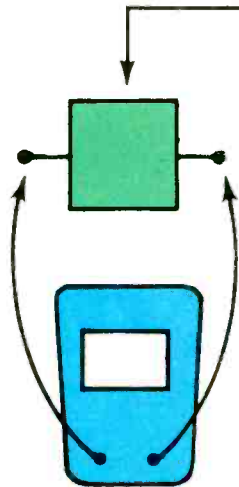

RESISTANCE = R

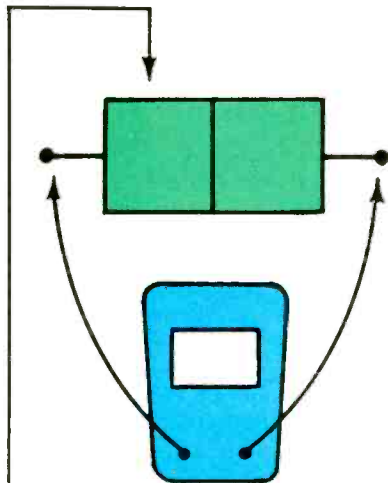

RESISTANCE = 2R

ALL SQUARES = SAME SIZE

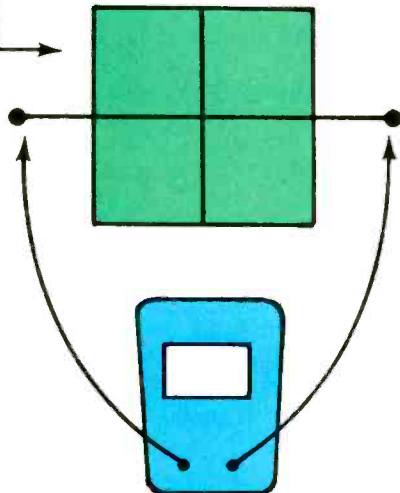

RESISTANCE = R

Figure 1. Sheet resistivity of thin films is measured in ohms per square. A square of a given material of a specified thickness will exhibit the same resistance as any other size square of the same thickness of the same material. That's because when you create a larger square, the greater resistance resulting from the greater distance across the square is exactly compensated for by the addition of resistance of the same magnitude in parallel.

reaction of a lot of people is to ask the question, "Per square what?" Sheet resistivity is measured simply in ohms per square.

This strange-seeming value comes about because of some interesting characteristics of thin films. If you deposit a specific material, say tantalum nitride, in a specified thickness, in a square pattern, no matter how large the square, the resistance measured across the square will be the same. A glance at Figure 1 will show why this is so.

ES&T

NEW! OPTIMA ELECTRONICS presents the **VIEWSTAR VSC 2500**
66-CHANNEL, REMOTE
CABLE CONVERTER

VIDEO TUNER WITH VOLUME CONTROL!

- 66-Channel Wireless Remote
- Switches TV on and off
- Remote Volume Control raises and lowers TV audio
- Receives ALL channels offered by your cable company
- Compatible with all brands of decoders
- Decoder Input/Output Jacks
- Remote channel changing
- Last channel recall
- Remote fine tuning
- Special Mute Button instantly silences TV sound — great for answering the phone or 'Killing' commercials
- Optional Audio and Video Outlets for direct hookup to VCR, TV Monitor or Video Transmitter

\$109⁹⁵

CALL TOLL FREE 1-800-327-0224
 FOR MORE INFORMATION
 IN FLA. CALL COLLECT 305-920-3550

SPORTS FANS!

One button instant channel switching lets you easily switch n' watch two events.

24-MONTH GUARANTEE

ORDER TODAY — SHIPPED WITHIN 24-HOURS

(On C.O.D. and Credit Card Orders)

ORDERS RECEIVED UP TO DEC. 12 GUARANTEED DELIVERY BEFORE XMAS

OPTIMA ELECTRONICS, 2022 Tigertail Blvd., Dania, FL 33004

Yes, rush me
 Cable Converters with volume control @ \$109.95
 Cable Converters without volume control @ \$89.80
 plus \$3.95 per item shipping. (Fla. residents add 5% tax.)
 Enclose check M.O. Visa MasterCard for \$ _____ TOTAL

SIGNATURE _____
 ACCT. NO. _____ Exp. Date _____
 NAME _____
 ADDRESS _____
 CITY _____ STATE _____ ZIP _____

OPTIMA ELECTRONICS also carries a fine line of replacement parts for TV, Stereo, VCR, Cable and Telephone Accessories!

Circle (13) on Reply Card



Index of 1986 Articles

Compiled By Warren G. Parker, Metairie, LA

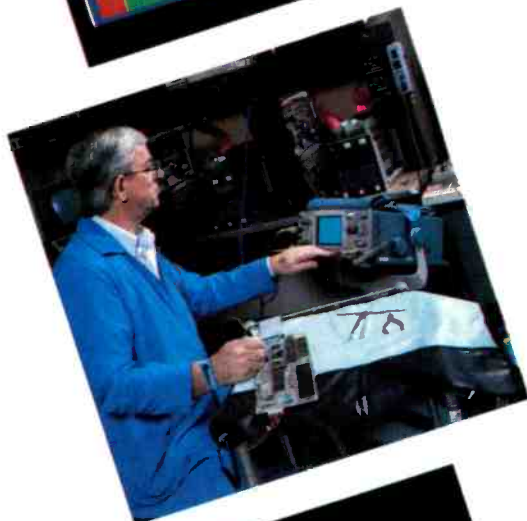

ARTICLES

ANTENNA SYSTEMS	Month	Page
Field strength meter or signal-level meter?	May	24
Satellite receiving antennas	Aug	40

AUDIO	Month	Page
Audio Corner	Jun 64, Jul 64, Aug 64, Sep 76, Oct 62, Nov 58, Dec 62	

COMPUTERS	Month	Page
Computer Corner	Oct 58, Nov. 62, Dec. 56	
Power protection for electronic equipment	Mar	37
Servicing the Commodore 64	Mar	10

MISCELLANEOUS ARTICLES	Month	Page
ABCs of voltage regulator ICs	Nov	39
Bug out!	Dec	44
Buying a DMM	Sep	12
Buying and fixing as-is electronic products	Jun	46
Why do components fail?	Nov	24
Double trouble	Jun	16
Index of 1986 articles	Dec	22
I only have two hands: Tools, jigs, fixtures	Jul	24
Dealing with power line problems	Nov	12
Replacement parts	Jun	40
Seeing digital circuit operation with a logic analyzer	Oct	39
Sharp high and low voltage circuits	Jul	14
Test your electronic knowledge	Jan 28, Feb 60, Mar 56, Apr 10, May 23, Jun 30, Jul 22, Aug 30, Sep 24, Oct 24, Nov 30, Dec 46	
TV camera test bench	Apr	12
Voltage breakdown in transistors	Jul	40
Watch your language	Dec	20
What do you know about electronics?	Jan 46, Feb. 52, Mar 50, Apr 58, May 54, Jun 54, Jul 52, Aug 56, Sep 66, Oct 54, Nov 52, Dec 50	
51-month Profax directory	Dec	27

NETWORK TELEPHONY	Month	Page
More on the telephone tester	Feb	37

REPORTS FROM THE TEST LAB	Month	Page
The Sencore LC-75	Oct	14

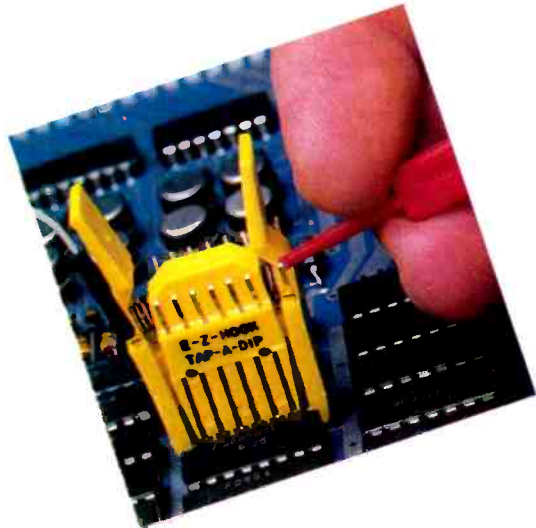

SERVICING METHODS

AN IMPORTANT NOTICE: Addendum to VCR head cleaning	Jan 45
Are you being chased by an overheated boomerang?	Aug 48
Horizontal and color problems in RCA CTC 107	Aug 12
Impedance testing methods	May 45
Introduction to microcomputer troubleshooting, Part 3	Jan 20
Maintenance and lubrication	Aug 22
Protecting against static electricity damage	Mar 22
RCA CTC 109A: Horizontal, high voltage, and vertical problems	Jan 8
Repairing flood damaged electronic equipment	Feb 49
Repairing the consumer color camera, part 2	Jan 38
Repairing the consumer video camera, part 3	Feb 40
Servicing Penney's vertical and luminance circuits	Apr 22
Servicing Ward's HV and LV circuits	Feb 10
Scoping TV power supply sources	Nov 46
Solder: The <i>tin</i> tie that binds	Feb 22
Test components and ICs with your scope	May 26
Test equipment for disk drives	Oct 26
Tests for low frequency amplifiers	Aug 56
The ups and downs of servicing vertical sweep	May 12
Troubleshooting audio equipment Supertech style	Dec 39
TV camera test bench	Apr 12
TV tests and measurements with a multimeter	Sep 26
TV troubleshooting hints and tips	Dec 14
Write it down (Efficient troubleshooting)	Mar 44

DEPARTMENTS

BOOK REVIEWS

Analog Electronics for Microcomputer Systems, by Paul Goldsbrough, Trevor Lund, and John Rayner	Jan 60
---	--------

	Month Page
Analog Printed Circuit Design and Drafting, by Darryl Lindsey	Feb 26
An Introduction to Circuits and Electronics, by J.R. Cogdell	May 53
Computer Power Buyers Guide, Wellspring Enterprises	Nov 51
Computer User's Guide to Electronics, by Art Margoulis	May 53
Designing IC Circuits, With Experiments, by Dalton Horn	Apr 73
Digital Electronics: Theory, Application, and Troubleshooting by Byron W. Putnam	Jan 60
Electrical Engineering Fundamentals, 2nd edition, by Vincent Del Toro	Jul 61
Electronic Devices and Circuits, David Bell	Nov 51
Electronic Prototype Construction, by Stephen Kasten	Feb 56
Electronics Math, by Bill Deem	Sep 63
Electronic Techniques: Shop Practices and Construction, 3rd edition, by Alexander Avtgis and Robert Villanucci	Apr 73
Electronic Servicing Data and Procedures, by Robert Genn Jr.	Dec 47
Handbook of Electronics Tables and Formulas, 6th edition, Howard W. Sams	Jul 61
How to Read Schematics, 4th edition, by Donald Herrington	Jun 60
Linear and Interface Circuits, D.E. Pippinger and E.J. Tobaben	Feb 56
Maintenance & Repair of VCRs, by Matthew Mandl	Mar 60
Microcomputer Operation, Troubleshooting and Repair, by Robert Paynter	Jul 61
Most-Often Needed 1926-1950 Philco Information, Kristina H. Beitman	Feb 56
New Channel Master Satellite Reception Equipment Service Manual	Dec 47
Pocket Digital Multimeter Techniques, by Homer Davidson	Aug 39
Principles of Digital Audio, by Ken Pohlmann	Aug 39
Reference Data For Engineers, 7th edition, by Edward C. Jordan	May 53
Sams/TI Basic Electricity Series, from Texas Instruments	Jun 60
Successful Sound Systems Operations, by F. Alton Everest	Jun 60
The CLR200...Camcorder Technical Training Manual, RCA	Apr 73
Troubleshooting and Repairing Satellite TV Systems, by Richard Mattox	Mar 60
Understanding Computer Science Applications, by Roger S. Walker	Jan 60
Understanding Series, Howard Sams/Texas Instruments	Nov 51
Video Electronics Technology, by David Graham	Jan 60
Video-Cable TV Workbook II, by Sandra Fleming	Sep 63
55 Easy-to-Build Electronic Projects, Editors, <i>Elementary Electronics</i>	Mar 60

PRODUCTS

An expanded line, <i>Kikusui</i>	Dec 60
Analog clamp-on multimeter, <i>Beckman Industries</i>	May 59
Analog/digital storage scope, <i>Kikusui</i>	Apr 70
Analog oscilloscope conversion, <i>Sibex</i>	Apr 67
Anti-static kit, <i>RCA Special Products Division</i>	Mar 57

	Month Page
Anti-static mat products, <i>Peak Products</i>	Mar 58
Autoranging DMM with memory, <i>EXTECH</i>	Apr 71
Autoranging digital capacitance meter, <i>Pilot Marketing</i>	May 60
Cable tie tool, <i>LYNX/Catamount</i>	Jun 62
Cable fault locator, <i>Tripplett</i>	May 58
Circuit cooler, <i>Vortec</i>	May 59
Circuit repair kit, <i>APE Corporation</i>	May 58
Cleaning, polishing brushes, <i>Eraser Company</i>	Jul 56
Coaxial cable stripper, <i>CO-AX 3, Davle Tech</i>	Jul 58
Compact DC supplies, <i>Kikusui International</i>	Jul 57
Complete PCB repair system, <i>APA Corporation</i>	Jan 59
Component analyzer, <i>Synchronicity Research</i>	Aug 60
Computer care kit, <i>Philips ECG</i>	Mar 57
Continuity tester, <i>Vaco Products</i>	May 58
Continuity tester audible/visual, <i>Desco Industries</i>	Sep 73
Conductive component carousel, <i>OK Industries</i>	Jul 58
Data line monitor, <i>L-Com Data Products</i>	Apr 70
Desoldering braid, <i>Philips ECG</i>	Feb 57
Desoldering handpumps, <i>APE Corporation</i>	Feb 57
Desoldering tips for SMDs, <i>Weller</i>	Dec 60
Diagnostic instrumentation kits, <i>Spanta</i>	Jan 59
Digital clamp-on VOA, <i>Mercer Electronics</i>	Jun 62
Digital multimeters, <i>Kernco Instruments</i>	Jul 56
Digital multimeter, <i>TIF</i>	May 60
Digital storage, auto setup scope, <i>Gould Electronics</i>	Apr 68
DMM designed for low lifetime costs, <i>Fluke Manufacturing</i>	Jan 59
DMM with built-in printer, <i>A.W. Sperry</i>	Mar 58
Dual-beam oscilloscope mainframe, <i>Iwatsu</i>	Apr 68
Dual trace portable scope, <i>Ballentine Laboratories</i>	Apr 68
Dynamic component analyzer, <i>Merc-O-Tronics Instruments</i>	May 60
Electronic servicing software, <i>Sperry Tech</i>	Jul 56
Electrostatic locator, <i>ACL</i>	Jun 61
Expand MM or display capability, <i>AEMC Corporation</i>	Sep 72
Floppy disk drive repair tool, <i>AVA Instrumentation</i>	Apr 67
Four extra hands, <i>Gripmate Enterprises</i>	May 58
Freez-it six pack, <i>Chemtronics</i>	Sep 72
Hand-held DMM has D factor, <i>American Reliance</i>	Dec 61
Hand-held dual trace scope, <i>Soar Corporation</i>	Apr 67
Hand-size digital testers, <i>Tripplett</i>	Dec 60
Hand tools tested at 10,000V, <i>Cementex</i>	Dec 61
High-leverage diagonal cutter, <i>Klein</i>	Jul 56
Hot tweezer tool, <i>Plato</i>	Feb 58
Identify unknown components, <i>Philips Test & Measuring Instruments</i>	Jun 62
Improved Z meter, <i>Sencore</i>	Jun 62
Isolated AC power source, <i>V 12 Test Equipment</i>	Apr 70

Multifunction capabilities, <i>AEMC</i>	May 58
Multimeters and accessories, <i>ECG</i>	Aug 60
New series of DMMs, <i>Philips Test & Measuring Instruments</i>	Sep 74
One-hand operation crimper, <i>Xcelite</i>	Jul 56
Oscilloscope/microprocessor, <i>Hitachi Denshi America</i>	Mar 58
Oscilloscope/VDT camera, <i>Soltec Distribution</i>	Sep 74
One-tube radio kit, <i>Antique Electronic Supply</i>	Apr 70
PCB gold repair service, <i>Alchemitron</i>	Jan 59
Plug-in surge suppressor, <i>Kalglo Electronics</i>	Jul 57
Portable static control work station, <i>Plastic Systems</i>	Mar 57
Portable video generator, <i>Network Tech</i>	Sep 72
Power supply line, <i>Global Specialties</i>	Mar 58
Precision frequency source, <i>Technical Novations</i>	Aug 60
Printed circuit board repair kit, <i>Jensen Tools</i>	Aug 60
Printed circuit repair modification kit, <i>Bishop Graphics</i>	Sep 73
Probe replacements, <i>E.F. Johnson</i>	Dec 61
Prototyping station, <i>Global Specialties</i>	Jun 62
Remote control transmitter, <i>Philips ECG</i>	Jan 59
Satellite test and troubleshooter, <i>Satellite Test Equipment</i>	Jun 61
Scope-DVM interface, <i>Creative Electronics</i>	May 60
Scope with built-in component checker, <i>A.W. Sperry Instruments</i>	Apr 68
Semi-automatic distortion meter, <i>Leader Instruments</i>	Sep 74
Semiconductor general-purpose replacements, <i>Howard W. Sams</i>	Dec 61
Shaft cutter, <i>Turnex International</i>	Aug 60
Smallest hand-held DMM, <i>A.W. Sperry</i>	Dec 60
SMD removal/replacement, <i>Micro Electronic Systems</i>	Jul 58
SMD test tweezers, <i>ITT Pomona Electronics</i>	Feb 58
Soldering/desoldering station for SMD technology, <i>Jensen Tools</i>	Jun 61
Soldering iron's cermet element, <i>Oryx</i>	Apr 70
Soldering temperature control, <i>Weller</i>	Jun 62
Specialty chemical line, <i>CRC Chemicals</i>	Sep 73
Standby power systems, <i>RTE Deltec</i>	Sep 72
TTL IC comparator tester/logic monitor, <i>B&K Precision</i>	Mar 58
Telephone loop tester, <i>Tripplett</i>	Apr 70
Temperature recording labels, <i>SAT, Spirig</i>	Feb 58
Test equipment update, <i>Huntron Instruments</i>	Apr 70
Test jig adaptor, <i>Telematic</i>	Mar 58
Test powered/unpowered circuits, <i>Desco Industries</i>	Jul 58
Three position soldering station, <i>Hexacon</i>	Sep 73
Triple soldering tool station, <i>Edsyn</i>	Jul 58
TV stereo synthesizer, <i>Teletronics Sound Systems</i>	Aug 60
Variable sensitivity control, <i>Riser-Bond Instruments</i>	May 58
Wireless home video transmission, <i>Wawasee Electronics</i>	Feb 57
Wire strippers, <i>GC Electronics</i>	Mar 57
1 MHz high-voltage probe, <i>TPI</i>	Jun 63
3-channel oscilloscopes, <i>Iwatsu Instruments</i>	Feb 58
3 1/2 digit DMM, <i>Mercer Electronics</i>	Sep 72
4 1/2 digit hand-held DMM, <i>A.W. Sperry Instruments</i>	Feb 57

PROFAX

GENERAL ELECTRIC

	Month Page
BC-A chassis	2079
HP chassis, tuning and control systems	2084A
HP chassis, chroma	2084B
NF chassis	2087
PM-A chassis	2078
PM-C chassis	2088
TV/AM/FM clock radio	2092
X110 chassis, B&W TV	2091
X110 chassis (cont.)	2095
14" portable color TV, RS-A chassis	2094
25 PC(J) chassis	2082

RCA

CTC 117 chassis	2080
CTC 120 chassis	2083
CTC 125 chassis	2085
CTC 130-S1 chassis	2090
CTC 133 chassis	2081
CTC 136 chassis	2089
B&W TV basic service data, UVM chassis	2093
MMC 100, video monitor	2077
207 Series, weather clock	2086
UMJ chassis	2096

Profax schematics date from the October 1982 issue of ES&T. The 51-month directory of these schematics begins on page 27.

PROFAX—ISSUE CROSS REFERENCE

	Month Page
2077	Jan 86
2078	Jan 86
2079	Feb 86
2080	Feb 86
2081	Mar 86
2082	Apr 86
2083	Apr 86
2084A	May 86
2084B	May 86
2085	Jun 86
2086	Jun 86
2087	Jul 86
2088	Jul 86
2089	Aug 86
2090	Sep 86
2091	Oct 86
2092	Oct 86
2093	Nov 86
2094	Nov 86
2095	Dec 86
2096	Dec 86

TEST INSTRUMENTS High Quality Lowest Prices Off-The-Shelf

New! MINI-METERS w/MAXI-SPECS

SCOPE 3½ Digit LCD with 8 Full Functions

Model DVM-632 \$4495

Deluxe test leads included • 0.5% accuracy • Transistor gain test • Audible continuity checking & diode test • 10 Amp measurement

SCOPE 3½ Digit LCD Multimeter

Model DVM-630 \$2995

Test leads included • 0.5% accuracy • 6 functions, 19 ranges • Automatic zero adjust • Low battery indication • Measures 5" x 2¾" x 7/8"

B & K 20 MHz Dual Trace

Model 2120 \$37995

Probes included • 20 and 26 MHz band widths • TVV and TVH • X-Y operation • Trace rotation: adjustable front panel • Channel 1 output

Zippered Carrying Case CC-30... \$4.50

Phone orders accepted.

SCOPE 3½ Digit Capacitance

Model DCM-602 \$6995

Test leads included • 8 ranges with full scale values to 2000 uF • LSI circuit • Crystal time base • Frequency range 800 Hz to 8 Hz

SCOPE 3½ Digital Multimeters

Model DVM-638 \$7995

Test leads included • 11 function, 38 ranges • Logic level detector • Audible visual continuity • capacitance and conductance measurement.

Model DVM-634 \$4875 **Model DVM-636 \$6275**

• 7 function, 32 ranges • 8 function, 37 ranges
• Transistor measurement • Capacitance measurement

SCOPE Pocket Sized Audio Signal Generator

Model RC-555 \$6995

Test leads & 9V battery included • Low distortion sine-wave signal • 46 step selected frequency • x1 range 20 Hz to 1.5 KHz / x100 range 2KHz to 150 KHz

HITACHI 35 MHz Dual Trace Oscilloscope

Model V-355 \$59995

(Reg. \$899.95)
Probes included • Thin, lightweight, compact • Large 6" rectangular, internal graticule CRT • Autofocus

FORDHAM Sweep Function Generator

Model FG-801 \$19995

(Reg. \$289.95)
Test leads included • 7 frequency ranges, 0.2 Hz to 2 MHz • Accuracy to ±5%

FORDHAM 550 MHz Frequency Counter

Model FM-8 \$16995

(Reg. \$249.95)
Completely assembled, pre-tested, precalibrated • High intensity 8-digit LED display

SCOPE 4½ Digit LCD Bench Digital Multimeter

Model DVM-6005 \$19995

Test lead set & 6 "D" size batteries included • 0.4" high characters • Conversion period: 500 milliseconds • Automatic, negative polarity

Fordham

Ask for our **FREE** Catalog

TOLL FREE 800-645-9518

In New York State 800-832-1446

Service & Shipping Charge Schedule Continental U.S.A.

FOR ORDERS	ADD	FOR ORDERS	ADD
\$25-100	\$4.50	\$751-1,000	\$12.50
\$101-250	\$6.00	\$1,001-1,500	\$16.50
\$251-500	\$8.00	\$1,501-2,000	\$20.00
\$501-750	\$10.50	\$2,001 and up	\$25.00

260 Motor Parkway, Hauppauge, NY 11788

Circle (14) on Reply Card

SYMCURE

GENERAL ELECTRIC

	Month Page
AC chassis, Horizontal cannot be locked	Jul 60
AC chassis, No color	Jul 60
AC chassis, Has raster, no picture, no sound	Jul 60
AC chassis, Has no height, just a horizontal line	Jul 60
EC-D chassis, Will not start up	Jul 60
EC-D chassis, Insufficient or no vertical height	Jul 60

MAGNAVOX

E-31 chassis, Horizontal foldover and/or slow or no start up	Apr 66
E-31 chassis, Erratic shutdown	Apr 66
E-31 chassis, Regulated B $\frac{1}{2}$ is high, triggering shutdown	Apr 66
E-31 chassis, Intermittent start up, shutdown, or loss of horizontal locking	Apr 66
13 C 2 chassis, Constant shutdown	Apr 66
E-51 chassis, Immediate shutdown	Apr 66

PHILCO

E 06/E 21 chassis, Soft hum at low-volume settings	Nov 64
E 06/E 21 chassis, Intermittent vertical or horizontal locking	Nov 64
E 06/E 21 chassis, Picture (not raster) shifted to the left	Nov 64
E 06/E 21 chassis, As set warms, tint changes toward green	Nov 64
E 20/D 21 chassis, No color or weak color	Nov 64
E 06/E 20/E 21 chassis, R22 burned . . . and no raster	Nov 64

RCA

CTC131, Dark raster with HV but without picture	Mar 59
CTC131, No picture, but increasing screen control	Mar 59
CTC131, No voltages; fuse blown, Q101 chopper, shorted	Mar 59
CTC121, Picture too bright without control, but without trace lines	Mar 59
CTC120, When switched on, bright white screen is followed by shutdown	Mar 59
CTC120, No sound or picture, SCR is in tic-tic mode	Mar 59

SYLVANIA

E 32 chassis, Receiver dead, probably in shutdown	May 62
E 32 chassis, Horizontal frequency will not lock	May 62
E 32 chassis, Picture too bright with smeared video	May 62
E 32 chassis, Vertical black lines near center of picture	May 62
E 32 chassis, No color, left side	May 62
E 32 chassis, No sound, no $\frac{1}{3}$ 19.6 volt source	May 62

VIDEOCASSETTES

Manufactured by Matsushita, distributed by RCA, Panasonic, others.

	Month Page
Symcure 1, VCR displays clocks, has no functions. Power light, sensor lamp are not lighted	Sep 64
Symcure 2, Cassette cannot be loaded or unloaded, motor runs	Sep 64
Symcure 3, No sound; may "buzz" during playing	Sep 64
Symcure 4, VCR runs normally for a time, then goes into stop mode	Sep 64
Symcure 5, Snowy without color or intermittent color noise. Cleaning no help.	Sep 64
Symcure 6, VCR goes into stop mode a few seconds after loading	Sep 64
VCR Component Stock Numbers, <i>Panasonic</i> and <i>RCA</i>	Sep 64

TECHNOLOGY

Artificial intelligence: debunking the myths	Dec 10
Coming: High IQ VCRs	Oct 10
Coming: The super-smart credit card	Feb 8
Digital oscilloscope gives paper copy	Apr 8
Digital scopes make troubleshooting easier	Jun 10
Digital video copier—makes color prints	Aug 9
GEN-X software developed to assist servicing	Feb 6
LCD film pinpoints short circuits	May 8
LCD rivals the CRT	Jan 6
Micromounting microchips with a laser beam	Nov 11
New power switch for HV ICs	Jul 12
Portable oscilloscopes with built-in automation	Sep 7
Smallest color video camera	Jul 12
Tape deck automatically adjusts itself	Mar 7
(V)SRAM joins the DRAM	May 10

TROUBLESHOOTING TIPS

BOHSEI

TC-700 chassis, Fuse blows instantly	Nov 57
--	--------

GENERAL ELECTRIC

AB-C chassis, No sound or picture	Sep 62
EC-A chassis, No sound or picture	Mar 54
25YM, Sound but no raster	Dec 48

PANASONIC

CT309 chassis, Erratic starting	Nov 57
TR-504 1P chassis, Insufficient brightness control	Jul 50

QUASAR

ALDTS-989 chassis, Hum bar of noise	Mar 55
---	--------

RCA

CTC40 chassis, Vertical locks on very weak signals	Jan 58
KCS204C chassis, Dark picture	Jul 50

SHARP

19D72 chassis, No sound and no raster	Mar 54
---	--------

SYLVANIA

E 32-4 chassis, Insufficient contrast	Sep 62
E 51-04 chassis, Detuned push-button tuning	Jul 50

PROFAX

Compiled by Alisa Carter

	Profax number
OCTOBER 1982	
NEC color video monitor chassis Z7A	2000
RCA B&W TV chassis KCS 207B	2001
NAP color TV chassis 09C201 CQ4X	2002
NOVEMBER 1982	
Hitachi color TV chassis NP80SX	2003
RCA color TV chassis CTC 115	2004
NEC video projector chassis W2A-1	2005
DECEMBER 1982	
NAP B&W TV model MQA014GY (w/radio)	2006
RCA color TV chassis CTC 108	2007
JANUARY 1983	
Hitachi color TV GTX chassis No. 615	2008
RCA projection TV model PGR 200/300	2009
Magnavox B&W TV chassis 09M101	2010
FEBRUARY 1983	
Hitachi color TV, NP9X chassis	2011
RCA color TV, CTC 118 series	2012
MARCH 1983	
RCA B&W TV, chassis KCS 206C (ac/dc/battery)	2013
Hitachi projection color TV, CT 5011	2014
APRIL 1983	
General Electric color TV, AC-D AC-E	2015
NAP B&W TV, AM/FM radio UVG-1	2016
MAY 1983	
NAP color TV, chassis E34-18, -19, -32, -33	2017
GE B&W TV, XE chassis	2018
JUNE 1983	
RCA color TV, CTC 117 series	2019
NAP B&W TV, model B386QWA01	2020
JULY 1983	
Magnavox color TV, chassis E31-38	2021
Philco color TV, chassis K-20	2022
AUGUST 1983	
GE color TV, EM chassis	2023
NAP B&W TV, chassis 12M101	2024
SEPTEMBER 1983	
RCA color TV, chassis CTC 120	2025
NAP B&W TV, chassis 12M101	2026
OCTOBER 1983	
RCA B&W TV KCS205 series	2027
GE color TV, PM-A chassis	2028
NOVEMBER 1983	
RCA B&W TV KCS 204 series	2029
NAP color TV, 13C3 series	2030
DECEMBER 1983	
NAP color TV, 19C3 series	2031
GE color TV, PC-B chassis	2032

MCM ELECTRONICS Catalog #13 Is...



High Voltage!

It's a simple fact . . . All catalogs are NOT created equal. Some are more powerful than others.

One catalog stands alone in the highest category of them all — High Voltage — and it's available only from MCM Electronics.

Our catalog gives you the POWER to save money with affordable prices . . . the POWER to find the parts you need with our wide selection . . . plus the POWER of quick delivery.

Discover for yourself the High Voltage POWER of MCM's Catalog #13. Call TODAY for your FREE copy!

Call TODAY for our newest Catalog!

TOLL-FREE 1-800-543-4330

(In Ohio call 1-800-762-4315)

(In Hawaii or Alaska 1-800-858-1849)

858 E. Congress Park Drive • Centerville, Oh. 45459



MCM ELECTRONICS

A PREMIER Company

Source No. ES-16

Circle (15) on Reply Card

	Profax number
JANUARY 1984	
RCA KCS 206 B&W	2033
NAP E 34 chassis	2034
FEBRUARY 1984	
NAP 19 C 2 chassis	2035
RCA KCS 213 B&W	2036
MARCH 1984	
GE AF/C chassis	2037
APRIL 1984	
GE GL/X chassis	2038
GE XK B&W chassis	2039
NAP E 32 chassis	2040
MAY 1984	
RCA CTC 111 series	2041
JUNE 1984	
GE XJ B&W chassis	2042
NAP E 32-58, -59 chassis	2043
JULY 1984	
GE EC/K chassis	2044
NAP K 10 chassis	2045
AUGUST 1984	
RCA CTC 123 series	2046
NAP RD 425SI & RXC 192SL chassis	2047
SEPTEMBER 1984	
NAP E53-45, -46, -47, -48 chassis	2049
GE XE B&W chassis	2049
OCTOBER 1984	
RCA CTC 131/132 series	2050
NOVEMBER 1984	
GE AB/AC chassis	2051
NAP BD 3911 SL01 B&W chassis	2052
DECEMBER 1984	
RCA KCS B&W AM/FM/clock	2053
Hitachi NP 81 X chassis	2054
JANUARY 1985	
GE CM chassis	2055
NEC C13-304A chassis	2056
GE XM-E chassis	2057
FEBRUARY 1985	
GE PC-A chassis	2058
Hitachi CT2516 chassis	2059
MARCH 1985	
GE GK chassis	2060
Hitachi CQ4X chassis	2061
APRIL 1985	
RCA CTC 117 chassis	2062
NAP UXC chassis	2063
MAY 1985	
GE EC-A chassis	2064
NEC DJ-60EN(R) chassis	2065

JUNE 1985		Profax number
GE EP-B chassis		2066
JULY 1985		
GE 19PC-F/H chassis		2067
AUGUST 1985		
GE PM-B chassis		2068
SEPTEMBER 1985		
NAP EC-31-52, -56, & -58 chassis		2069
RCA CTC 118 chassis		2070
OCTOBER 1985		
NAP E-34-18, -32, & -33 chassis		2071
RCA CTC 121 chassis		2072
NOVEMBER 1985		
GE BC-N chassis		2073
GE EP chassis		2074
DECEMBER 1985		
GE PC-J chassis		2075
RCA CTC 126 chassis		2076
JANUARY 1986		
RCA MMC 100, video monitor		2077
GE PM-A chassis		2078
FEBRUARY 1986		
GE BC-A chassis		2079
RCA 117 chassis		2080
MARCH 1986		
RCA CTC 133 chassis		2081
APRIL 1986		
GE 25 PC(J) chassis		2082
RCA CTC 120 chassis		2083
MAY 1986		
GE HP chassis, tuning & control systems		2084A
GE HP chassis, chroma		2084B
JUNE 1986		
RCA CTC 125 chassis		2085
RCA 207 series, weather clock		2086
JULY 1986		
GE NF chassis		2087
GE PM-C chassis		2088
AUGUST 1986		
RCA CTC 136 chassis		2089
SEPTEMBER 1986		
RCA CTC 130-S1 chassis		2090
OCTOBER 1986		
GE X110 chassis, B&W TV		2091
GE TV/AM/FM clock radio		2092
NOVEMBER 1986		
RCA B&W TV basic service data, UVM chassis ..		2093
GE 14" portable color TV, RS-A chassis		2094
DECEMBER 1986		
GE X110 chassis (cont.)		2095
RCA UWJ chassis		2096

Profax Directory — by number

Profax Number	Month	Year
2000 — 2002	Oct	82
2003 — 2005	Nov	82
2006 — 2007	Dec	82
2008 — 2010	Jan	83
2011 — 2012	Feb	83
2013 — 2014	Mar	83
2015 — 2016	Apr	83
2017 — 2018	May	83
2019 — 2020	Jun	83
2021 — 2022	Jul	83
2023 — 2024	Aug	83
2025 — 2026	Sep	83
2027 — 2028	Oct	83
2029 — 2030	Nov	83
2031 — 2032	Dec	83
2033 — 2034	Jan	84
2035 — 2036	Feb	84
2037	Mar	84
2038 — 2040	Apr	84
2041	May	84
2042 — 2043	Jun	84
2044 — 2045	Jul	84
2046 — 2047	Aug	84
2048 — 2049	Sep	84
2050	Oct	84
2051 — 2052	Nov	84
2053 — 2054	Dec	84
2055 — 2057	Jan	85
2058 — 2059	Feb	85
2060 — 2061	Mar	85
2062 — 2063	Apr	85
2064 — 2065	May	85
2066	Jun	85
2067	Jul	85
2068	Aug	85
2069 — 2070	Sep	85
2071 — 2072	Oct	85
2073 — 2074	Nov	85
2075 — 2076	Dec	85

2077 — 2078	Jan	86	2087 — 2088	Jul	86
2079 — 2080	Feb	86	2089	Aug	86
2081	Mar	86	2090	Sep	86
2082 — 2083	Apr	86	2091 — 2092	Oct	86
2084A-2084B	May	86	2093 — 2094	Nov	86
2085 — 2086	Jun	86	2095 — 2096	Dec	86

PTS SLASHES MODULE PRICES UP TO 40%!

Your new PTS Product Guide has great news. PTS is cutting prices on popular modules by 10 to 40%! Choose quality PTS replacement parts. You get automatic updates, full year limited warranty, and instock availability or fast 8-hour turnaround of all makes/ all models.

Plus you get real savings.

More professionals choose PTS rebuilt modules than any other. Put PTS to work for you.

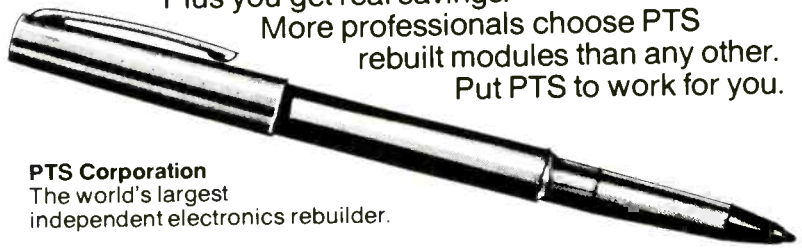

PTS Corporation
The world's largest independent electronics rebuilder.

Send for your free Product Guide today!



PTS Corporation
P.O. Box 272
Bloomington, IN 47402
(812) 824-9331

RCA MODULE #	REPAIR PRICE	RCA MODULE #	REPAIR PRICE
MAG001B	13.15	MCH001B	17.05
MAH001B	14.35	MAE001B	12.85
MDR001A	12.95	MDS001A	15.05
MDG001A	15.35	MCS001A	14.50
MAH004C	17.40	MDS001B	10.00
MCH002B	17.05	MAC002B	12.00
MDD001A	12.20	MDL002A	16.30
MDC001A	17.85	MCL002A	18.35
MAD001	11.00	MAG004A W	23.95
	9.10	MAA001A	8.30
		MAST007	30.50

Circle (16) on Reply Card

Product safety should be considered when component replacement is made in any area of a receiver. The shaded areas of the schematic diagram designate the components in which safety is of special significance. It is recommended that only exact cataloged parts be used for replacement of these components.

Use of substitute replacement parts that do not have the same safety characteristics as recommended in factory service information may create shock, fire, excessive x-radiation or other hazards.

This schematic is for the use of qualified technicians only. This instrument contains no user-serviceable parts.

The other portions of this schematic may be found on other Profax pages.

DMR-155 ELECTRONIC TUNING SYSTEM SCHEMATIC DIAGRAM X110 CHASSIS

(MODEL: 8-2569)

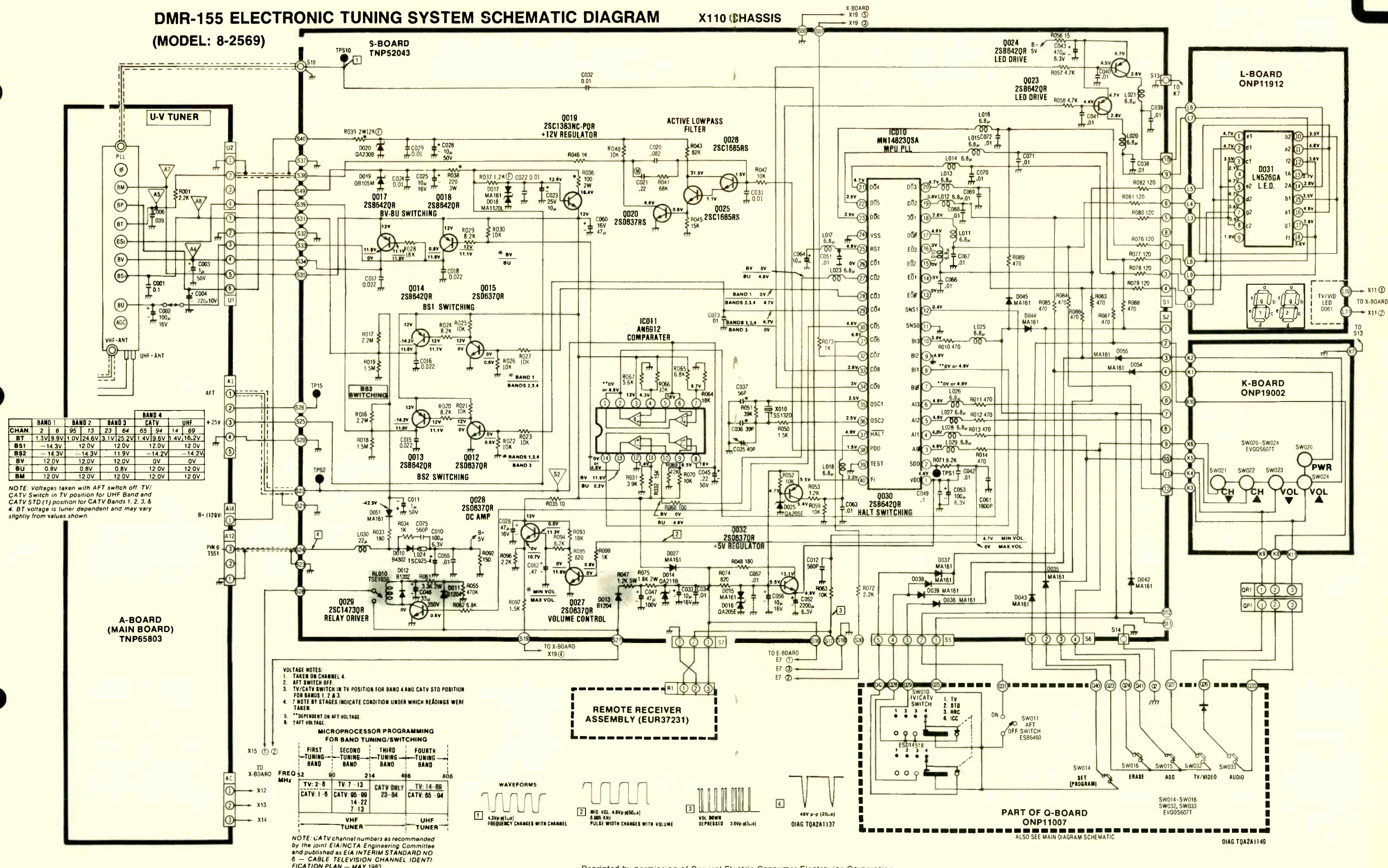

Product safety should be considered when component replacement is made in any area of a receiver. A star next a component symbol number and a star(s) on, or surrounding schematic symbols designate components that have special safety characteristics. Only the exact manufacturer's specified parts should be used as replacements. Use of substitute replacement parts that do not have the same safety characteristics as recommended in factory service information may create shock, fire, excessive x-radiation or other hazards.

The other portions of this schematic may be found on other Profax pages.

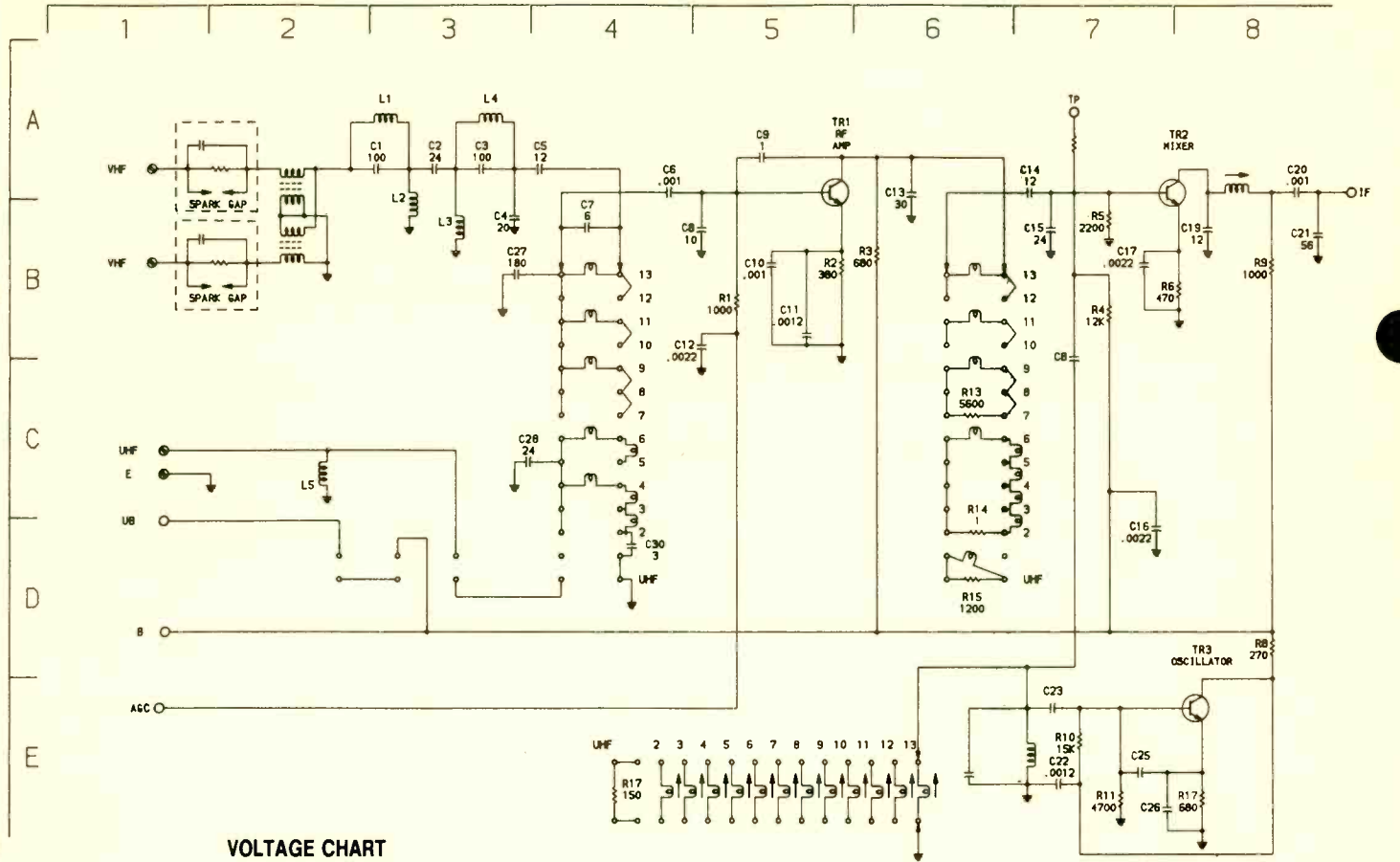
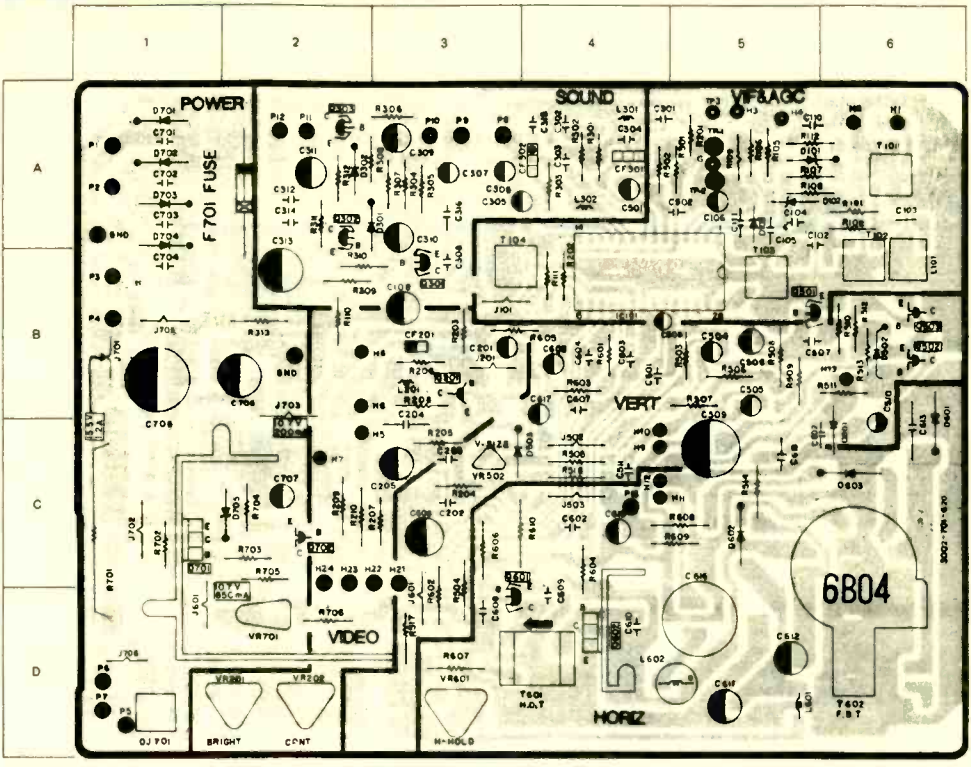

VOLTAGE CHART

Measured with high impedance V.T.V.M. or circuit tester under line voltage 120V
Voltage reading may vary ±10%

Tr. No.	Tr. Type	Function	Operating Condition	Base	Emitter	Collector
Q201	KSC2310 (O)/(Y)	VIDEO OUTPUT	No Signal	5.7V	5.3V	70.2V
			1000u V B&W Signal	5.6V	5.5V	67.5V
Q301	KSC945 (O)/(Y)	AUDIO DRIVE	No Signal	0.72V	0.04V	6.8V
			1000u V B&W Signal	0.72V	0.05V	6.8V
Q302	KSD261 (O)/(Y)	AUDIO OUTPUT	No Signal	8.2V	7.6V	16.6V
			1000u V B&W Signal	8.2V	7.6V	16.5V
Q303	KSA643 (O)/(Y)	AUDIO OUTPUT	No Signal	6.8V	7.4V	0V
			1000u V B&W Signal	6.8V	7.4V	0V
Q501	KSC945 (O)/(Y)	VERT. DRIVE	No Signal	0.5V	0V	6.2V
			1000u V B&W Signal	0.5V	0V	6.2V
Q502	KSC2331 (O)/(Y)	VERT. OUTPUT	No Signal	7.3V	6.7V	16V
			1000u V B&W Signal	7.2V	6.7V	16.2V
Q503	KSA931 (O)/(Y)	VERT. OUTPUT	No Signal	6.2V	6.7V	0V
			1000u V B&W Signal	6.2V	6.7V	0V
Q601	KSC815 (O)/(Y)	HORIZ. DRIVE	No Signal	0.5V	0V	10.3V
			1000u V B&W Signal	0.5V	0V	10.2V
Q602	KSD362 (N)/(R)	HORIZ. OUTPUT	No Signal	0V	0V	17.2V
			1000u V B&W Signal	0V	0V	17.2V
Q701	KSA614 (O)/(Y)	VOLTAGE REGULATOR	No Signal	15.8V	16.8V	10.7V
			1000u V B&W Signal	16.5V	17V	10.7V
Q702	KSD261 (O)/(Y)	ERROR AMP.	No Signal	3.7V	3V	15V
			1000u V B&W Signal	3.7V	3V	15V

IC VOLTAGE CHART

IC101 AN5151. VIF Amp. & DET. SIF Amp. & DET. AGC, Vertical OSC. & Drive Horizontal OSC. & Drive, sync. Sep.

Pin No.	1	2	3	4	5	6	7	8	9	10	11	12	13	14
No Signal	4.8	5.9	2.5	8.1	4.4	6.4	3	3	4.7	4.7	2.5	6.5	3.6	6.9
1000u V Signal	4.7	5.9	8.3	5.1	3.5	7.4	3	3	4.7	4.7	2.2	0.6	3.6	6.9

Pin No.	15	16	17	18	19	20	21	22	23	24	25	26	27	28
No Signal	7	9.7	0.8	5.4	5.4	10.3	0	3.5	0.4	5.2	1.04	6	0	4.8
1000u V Signal	6.9	9.7	0.7	5.4	5.5	10.3	0	3.4	0.9	5	0.9	5.8	0	4.8

Unit: Volt

COMPONENT LOCATION GUIDE

C102	5A	C607	4B	R307	3A	D302	2A
C103	6A	C608	3D	R308	2A	D502	6B
C104	5A	C609	4D	R309	2B	D503	3C
C105	5A	C610	4D	R310	2B	D601	6C
C106	5A	C611	5D	R311	2A	D602	5C
C108	3B	C612	5D	R312	2A	O603	6C
C110	5A	C613	6C	R313	2B	O701	1A
C111	5A	C615	4C	R501	5A	O702	1A
C201	3C	C616	5D	R502	4A	O703	1A
C202	3C	C617	4B	R503	5B	O704	1A
C203	3C	C619	5C	R504	3D	O705	1C
C204	3C	C701	1A	R505	4C	D801	6C
C205	3C	C702	1A	R506	5B	Q201	3B
C301	4A	C703	1A	R507	5B	Q301	3B
C302	4A	C704	1B	R508	5B	Q302	2A
C303	4A	C705	1B	R509	5B	Q303	2A
C304	4A	C706	2B	R510	6B	Q501	5B
C305	3A	C707	2C	R511	6B	Q502	6B
C306	3A	C802	5C	R512	6B	Q503	6B
C307	3A	R101	6A	R513	6B	O601	3D
C308	3B	R102	6A	R514	5C	O602	4D
C309	3A	R105	5A	R516	4C	Q701	1C
C310	3A	R106	5A	R517	3D	Q702	2C
C311	2A	R107	5A	R601	4B	CF201	3B
C312	2A	R108	5A	R602	3D	CF301	4A
C313	2B	R109	5A	R603	4B	CF302	4A
C314	2A	R110	2B	R604	4C	T101	6A
C315	4A	R111	4B	R605	3B	T102	6B
C316	3A	R112	5A	R606	3C	T103	5B
C501	4A	R201	5A	R607	3D	T104	3B
C502	5A	R202	4B	R608	5C	T601	4D
C503	4B	R203	3B	R609	5C	T602	6D
C504	5B	R204	3C	R610	3C	L101	6B
C505	5B	R205	3C	R701	1C	L201	3B
C506	5B	R206	3B	R702	1C	L301	4A
C507	5B	R207	2C	R703	2C	L302	4A
C509	5C	R208	3B	R704	2C	L601	5D
C510	6C	R209	2C	R705	2C	L602	5D
C511	4C	R210	2C	R706	2D	VR202	2D
C601	4C	R301	4A	IC101	4B	VR502	3C
C602	4C	R302	4A	D101	5A	VR601	3D
C603	4B	R303	4A	D102	5A	VR701	2D
C604	4B	R304	3A	D103	5A	DJ701	1D
C605	4B	R305	3A	D301	2A	F701	2A
C606	3C	R306	3A				

The other portions of this schematic may be found on other Profax pages.

STEREO/SAP SCHEMATIC DIAGRAM (MODEL: 8-2569)

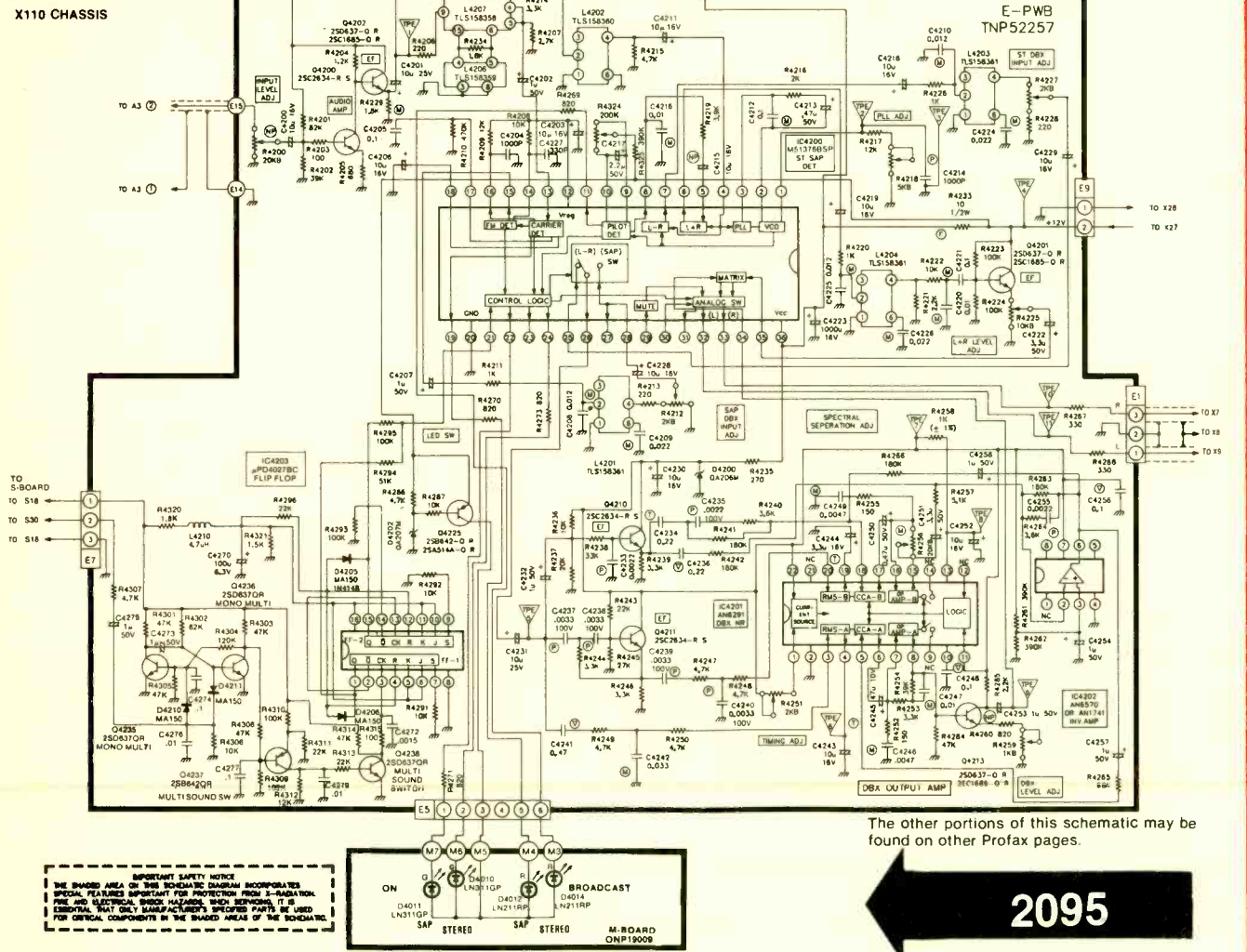

The other portions of this schematic may be found on other Profax pages.

Product safety should be considered when component replacement is made in any area of a receiver. A star next a component symbol number and a star(s) on, or surrounding schematic symbols designate components that have special safety characteristics. Only the exact manufacturer's specified parts should be used as replacements. Use of substitute replacement parts that do not have the same safety characteristics as recommended in factory service information may create shock, fire, excessive x-radiation or other hazards.

Product safety should be considered when component replacement is made in any area of a receiver. A star next a component symbol number and a star(s) on, or surrounding schematic symbols designate components that have special safety characteristics. Only the exact manufacturer's specified parts should be used as replacements. Use of substitute replacement parts that do not have the same safety characteristics as recommended in factory service information may create shock, fire, excessive x-radiation or other hazards.

MAIN SCHEMATIC, BWT128E

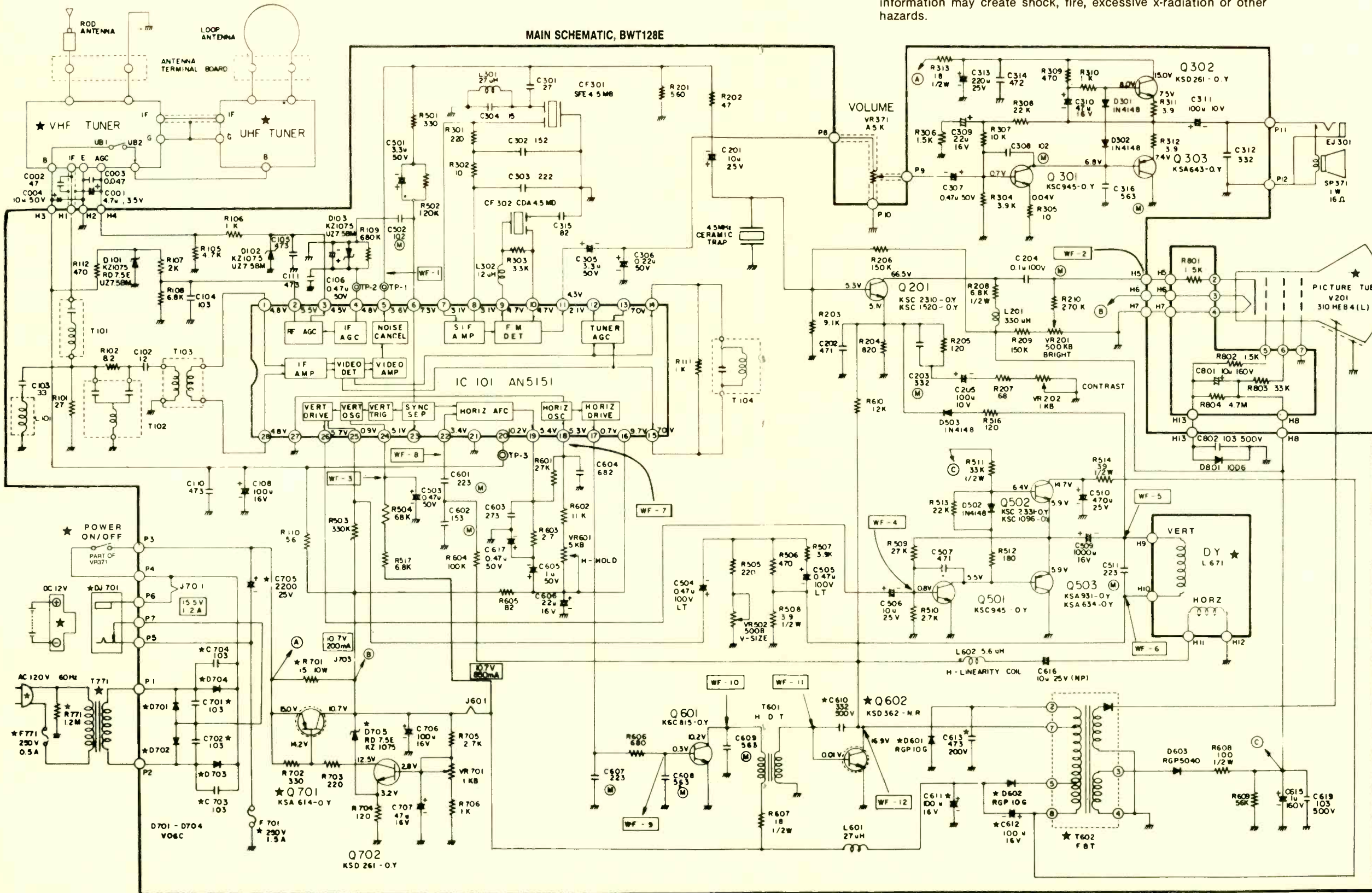



Audio servicing step by step

By David Miga, CET

Visual observation, troubleshooting, repair and maintenance are the four steps to the successful repair of electronic audio equipment.

There are four steps to the successful repair of electronic audio equipment: visual observation, troubleshooting, repair and maintenance, although not necessarily in that order, as we shall see. We will look at some common complaints and remedies of problems with amplifiers and receivers (both older units and the new microprocessor-controlled units) and tape decks (reel-to-reel and cassette.)

Receivers and amplifiers

The most common complaints of these units are "one channel out," "both channels out," "one channel lower than the other," "intermittent cuts in and out," etc. Many

technicians make the mistake of spending too much time troubleshooting instead of looking for the most obvious clues. Five minutes of *thorough* visual observation can save you many hours of troubleshooting. The technician who spends two hours with a protection circuit problem on a Pioneer SX-950 only to trace it to a loose fuse holder will remember these two steps: static observation and dynamic observation.

Static observation: Check all fuses with an ohmmeter and be sure the fuse holders are holding the fuses tight enough. Also, be sure the fuses are of the correct value. Look for obvious burnt PC foils, discolored resistors or recent soldering. If the outside of the cabinet looks damaged, look for cracked PC boards inside.

Dynamic observation: Plug the

unit into a "safety socket" (this is nothing more than an extension cord with one wire cut and a 100W bulb in series with the load). The bulb should light briefly and dim down as the power supply capacitors charge, and if the unit has a speaker relay, it should click in after a few seconds. Assuming this happens and you can tune in a station or run a signal into the auxiliary input, operate *all* the switches and controls one by one. You might find that the "intermittent left channel" or "one channel dead" is just a dirty tape monitor switch or input selector.

If the bulb stays bright, you have something shorted in the unit (and you just saved yourself a fuse). The only way to find the shorted components is statically. Unplug the unit and with your ohmmeter or the diode test function of your

TENTEL MAKES IT EASY TO DIAGNOSE VCR MECHANICS

Award winning Tentelometer tape tension gauge for proper interchange and tape handling. One gauge for Beta, VHS and U-Matic.
T2-H7-UM \$295

Torque gauge NEW from Tentel to save you money— Universal and accurate for Beta and VHS— 0 to 600 gm cm. Take-up, FF and Rew torques.
TQ600 \$129

Head protrusion and eccentricity gauge to determine the amount of wear remaining on the VCR heads; safe, easy, measures in microns.
HPG-1 \$479

Spindle height and elevator latch and alignment gauge to diagnose cassette binding and edge damage problems. Finds problems not detected by any other method.
TSH-V4 \$395

Tentel manufactures a complete line of gauges for U-matic, 1" Type "C", Betacam and other recorders, too. If you've suffered the frustration of having a master tape ruined, or if you are responsible for maintaining and repairing VCRs— There's no faster, easier method to test the various mechanics that make VCRs work properly. Call our technical engineering dept. for details—ask about the combo discount for all 4 gauges. We've been helping customers for years and want to help you too—your satisfaction is guaranteed.

TENTEL CORP. 1506 Dell Ave. (408) 379-1881
Campbell, CA 95008 800 538-6894 (Not in CA)

Circle (35) on Reply Card

DMM, measure the most obvious: shorted power supply diodes and audio output transistors reign supreme. If you find the audio outputs shorted in one channel, remove them from the circuit, plug the unit back into the safety socket and check the other channel and all other functions.

When repairing a direct-coupled amplifier with shorted output transistors, it is *very* important to statically check the driver and pre-driver transistors and all low value (under 5k) metal oxide fireproof resistors in the circuit. It is a very rare amplifier that blows only the outputs, and the unwary technician who simply replaces the output transistors and turns the unit *on*, hoping for the best, will soon find that another set of outputs has just been blown. When soldering output transistors or any other components that must be mounted to a heat sink, always solder the leads *after* the component is mounted. Otherwise, premature failure could occur.

When you are reasonably sure that you have replaced all of the defective components, plug the unit into the safety socket, and with no speakers hooked up, turn

the unit *on* and measure the dc voltage at the amplifier output before the speaker relay. If you have more than a volt, you missed something (did you check the bias diode or transistor on the heat-sink?). Don't make the mistake of trying to troubleshoot the unit

**It is a very rare amplifier
that blows only the
outputs**

dynamically with voltage comparisons from the schematic; with dc-coupled amplifiers using negative feedback, you're just wasting time. Checking semiconductors statically with a semiconductor analyzer and resistors with the *low ohms* position of your DMM is the best method.

Amplifiers with intermittent problems have been known to make some technicians turn to drink and others to become believers in the supernatural. Here again, if certain steps had been taken, those technicians would have been working on the next

customer's unit instead of dying on this one.

Solder one end of a grain of wheat bulb at the amplifier's output before the speaker relay, and the other end to ground (do this to both channels). The voltage of the bulbs is dependant on the amplifier's size, so use the rail voltage as a guide. Turn the amplifier *on* with the speakers hooked up and listen to some music while you're working on something else. When you hear the amplifier act up, look at the bulbs. If the bulbs show that both channels are experiencing the same problem, the chances are that the amplifiers are OK and the problem is in the power supply or protection circuit. If just one channel acts up, look for thermally noisy differential transistors (a common Pioneer trait) or a noisy dc offset or bias trimmer (a common Sansui trait), or a leaky electrolytic capacitor at the last stage of the tone circuit before the amplifier. Incidentally, noisy transistors and leaky capacitors sound different; low frequency thumping is usually a leaky electrolytic, while sharp snapping is usually a noisy semiconductor.

Electronics servicing chemicals provide an arsenal of products for use in audio servicing. Freeze sprays simplify component cooling for troubleshooting purposes, solvents provide cleaning for both mechanical and electrical/electronic components.



If the problem seems to be common to both channels, suspect the power supply first. Regulators of the TO-220 case style will become intermittent if they are mounted to a too-small heat sink (Pioneer again). Simply compare output voltages with the schematic when the unit acts up; sometimes you can find the defective component in a jiffy with a can of Freon freeze spray. Look for oxidized PC board solder connections at the regulators and their support components (Yamaha and Pioneer).

In some cases, the protection circuits themselves can cause the intermittent problem; this is almost always caused by leaky transistors in the early stages of the protection circuit (Sony and Kenwood). Heating the transistors with a common hair dryer and then freeze-spraying them one at a time will usually find the defective component quickly.

More amplifier problems difficult to find are such complaints as "one channel lower/louder than the other" and "output pops when low filter switch is activated." This is usually associated with older units and is always (well, almost) a leaky or open electrolytic capacitor. Rather than spend time troubleshooting to the component itself, it is usually quicker to replace all the electrolytics in the offending stage (Pioneer, Fisher). Also, keep in mind that the older units will have enough wear on the balance and volume controls that they may not vary both channels equally (but you would have found that when you did the "dynamic observations" step...right?).

After you have repaired the unit, it's time to do maintenance; if nothing else, it will lessen the chances of a "call-back" because you have overlooked something. An amplifier that comes in with a channel blown that you have repaired may blow up again because you didn't clean and adjust the bias trimpot, so spray a good Freon/silicon-based cleaner on the dc offset and bias trimmers before adjusting them to the manufacturer's specifications. Also spray all the switches and controls on the

Exclusive, triple patented dynamic cap and coil analyzing . . . guaranteed to pinpoint your problem every time or your money back



with the all new LC75 "Z METER 2"
Capacitor Inductor Analyzer
Patented \$995

The "Z METER" is the only LC tester that enables you to test all capacitors and coils dynamically — plus, it's now faster, more accurate, and checks Equivalent Series Resistance (ESR) plus small wire high resistance coils.

Eliminate expensive part substitution and time-consuming shotgunning with patented tests that give you results you can trust every time. Test capacitor value, leakage, dielectric absorption, and ESR dynamically; with up to 600 volts applied for guaranteed 100% reliable results — it's exclusive — it's triple patented.

Save time and money with the only 100% reliable, in- or out-of-circuit inductor tester available. Dynamically test inductors for value, shorts, and opens, automatically under "dynamic" circuit conditions.

Reduce costly parts inventory with patented tests you can trust. No more need to stock a large inventory of caps, coils, flybacks, and IHVTs. The "Z METER" eliminates time-consuming and expensive parts substituting with 100% reliable LC analyzing.

Turn chaos into cash by quickly locating transmission line distance to opens and shorts to within feet, in any transmission line.

Test troublesome SCRs & TRIACs easily and automatically without investing in an expensive second tester. The patented "Z METER 2" even tests SCRs, TRIACs, and High-Voltage Diodes dynamically with up to 600 volts applied by adding the new SCR250 SCR and TRIAC Test Accessory for only \$148 or FREE OF CHARGE on Kick Off promotion.

To try the world's only Dynamic LC Tester for yourself, CALL TODAY, WATS FREE, 1-800-843-3338, for a FREE 15 day Self Demo.



Call Today Wats Free 1-800-843-3338

SENCORE

3200 Sencore Drive

Sioux Falls, SD 57107

605-339-0100 In SD Only

*innovatively designed
with your time in mind.*

Circle (17) on Reply Card

front panel and burnish the speaker relay contacts and any PC board edge connectors. If the unit is a receiver, align the FM tuner; the correct method is to adjust the discriminator coil first, then adjust the front end trimmer caps while tuned to the upper ranges of the FM band.

Microprocessor-controlled units

The reason you'll find that most technicians are scared to death to work on the newer digitally controlled equipment is because they overcomplicate a problem that could be easy to find if they only followed certain steps.

If the unit turns *on* but ignores all functions, first check power supply voltages; if the 6-V supply in the Pioneer SX-5 is 6½V, the MPU will not function! If voltages appear to be normal, check to see that the *clock* (i.e., crystal, ceramic resonator, etc.) is operating. Remember that all an MPU does is execute certain functions step by step. Without an oscillator to run it, it will stay stuck on one step until it grows hair. The most common failure with MPU-based units is the ceramic resonator; like a crystal, but lower in frequency, they often become intermittent. Substitution is the best method.

The third most common problem to look for is a stuck switch (Akai, Kenwood). The MPU is constantly scanning all its input switches, and if just one is pressed, the MPU will ignore all commands from the others. Incidentally, the switches don't have to be front-panel buttons; on cassette decks, micro-switches tell the MPU what position the mechanism is in, and the unit will not operate properly if these switches are intermittent.

If the MPU is operating and accepting commands, but it is doing some pretty strange things such as adjusting bass when the treble button is depressed, it has received a glitch in its program; find the reset pin and reset the MPU with an alligator clip (some receivers have a reset button on the rear panel). Most MPUs are designed to be reset at turn-on through a small electrolytic capacitor to ground, and some of them use batteries to keep the MPU's memory.

Unfortunately, a close lightning strike can reprogram the RAM inside the MPU and the customer will think that the unit is defective. Just short the reset pin to ground for a second and see if it corrects the problem. Replace the MPU only when you have determined that the supply, oscillator, switches and

reset capacitor are OK. After soldering, it is mandatory that the PC board be strip cleaned, as some MPUs have high impedance inputs that can be affected by contaminated rosin flux.

Tape decks

Remember when I said that the four steps to successfully repair a unit were visual observation, troubleshooting, repair and maintenance, but not necessarily in that order? Whenever you are dealing with anything mechanical, suspect a mechanical failure before an electronic one. To spend time troubleshooting a "low record" problem to a dirty tape head is SHAMEFUL. As usual, go through the visual observation, but instead of troubleshooting next, do maintenance instead. You'll find that 90% of most complaints with tape recording equipment will vanish once maintenance has been done.

Clean the heads, capstan and pinch roller with toluene (GC Electronics *Service Solvent*). This removes the dead rubber and, frankly, does a better job of revitalizing old rubber than most of the solvents sold only for that purpose. Also clean the pulleys that the belts and idlers come in

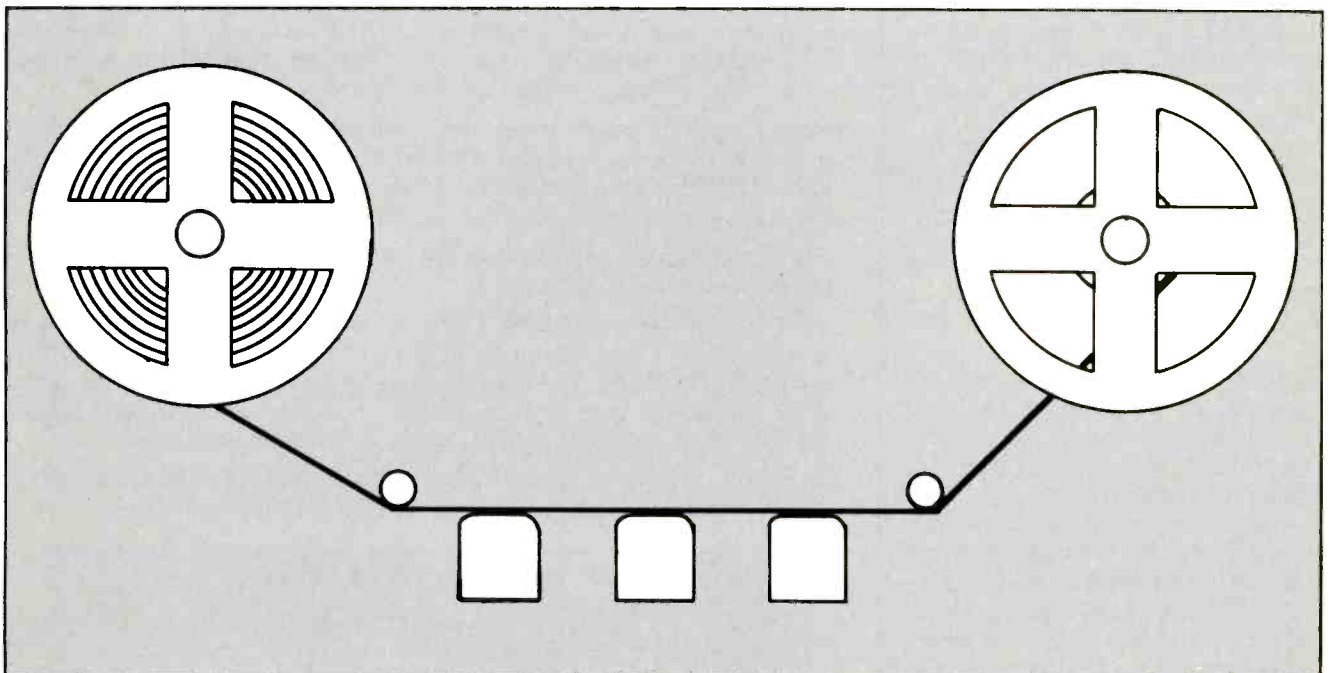

Cleaning the tape path, heads, capstan, pinch roller and pulleys will clear up most complaints about tape recording/playing equipment.

contact with, as well as the tape guide path.

After cleaning the belts, hold the flywheel immobile and turn the motor *on*. If the motor spins, the belt is stretched and must be replaced. On most units, the length of the belt actually will change the tape speed, so be sure you replace the belt with the size recommended by the manufacturer. If the customer complained of a speed problem with a cassette deck, find the switch that activates the motor when the mechanism is activated and burnish it (Pioneer, JVC).

After all maintenance has been done, check the speed, wow and flutter, rewind, fast forward and take-up torque. Research has shown that most people hear slow music more readily than fast, so set the motor speed (if adjustable) to between 0.0% and 3% fast.

Now that maintenance has been done, you'll probably have a working unit. But in case you don't, here are some pointers to look for: Worn motors will vary their speed if tapped on with a small screwdriver handle; replace them. A cassette deck with no play or record in one channel is almost always a defective Dolby chip. Recording levels lower in the right channel in comparison to the left channel signifies a worn head; replace and align it. Intermittent motor operation in cassette decks is usually the motor microswitch buried in the mechanism (did you burnish it while doing maintenance?). Reel-to-reel decks that intermittently stop for no reason usually have thermally defective supply regulators of the TO-220 case style (Akai, Dokorder). Cassette decks that do the same thing usually have loose tape counter/motion detector belts. Some newer units use a mechanical system for measuring tape motion; be sure that they are not binding.

The steps outlined in this article could turn an average technician into a good one, and a good technician into a "Supertech."

David T. Miga is an FCC licensed, Certified Electronic Technician (ISCET) with 16 years of experience in repairing consumer electronic equipment. Now as an engineering technician with Electronic Design Specialists, he has designed many test equipment, alarm, audio and digital circuits.

Analyze defective waveforms faster, more accurately, and more confidently — every time or your money back



with the SC61 Waveform Analyzer
Patented \$2,995

If you value your precious time, you will really want to check out what the exclusively patented SC61 Waveform Analyzer can do for you. 10 times faster, 10 times more accurate, with zero chance of error.

End frustrating fiddling with confusing controls. Exclusive ultra solid ECL balanced noise cancelling sync amplifiers, simplified controls, and bright blue dual trace CRT help you measure signals to 100 MHz easier than ever.

Accurately and confidently measure waveforms from a tiny 5 mV all the way to a whopping 3,000 V without hesitation with patented 3,000 VPP input protection — eliminates expensive "front end" repairs and costly equipment downtime.

Make only one circuit connection and push one button for each circuit parameter test: You can instantly read out DC volts, peak-to-peak volts and frequency 100% automatically with digital speed and accuracy. It's a real troubleshooting confidence builder.

Confidently analyze complex waveforms fast and easily. Exclusive Delta measurements let you intensify any waveform portion. Analyze glitches, interference signals, rise or fall times or voltage equivalents between levels; direct in frequency or microseconds.

Speed your digital logic circuit testing. Analyzing troublesome divide and multiply stages is quicker and error free — no time-consuming graticule counting or calculations. Simply connect one test lead to any test point, push a button, for test of your choice, for ERROR FREE results.

To see what the SC61 can do for your troubleshooting personal productivity and analyzing confidence, CALL TODAY, WATS FREE, 1-800-843-3338, for a FREE 15 day Self Demo.



Call Today Wats Free 1-800-843-3338

SENCORE

3200 Sencore Drive
Sioux Falls, SD 57107
605-339-0100 In SD Only

*innovatively designed
with your time in mind.*

Circle (18) on Reply Card

BUG OUT!

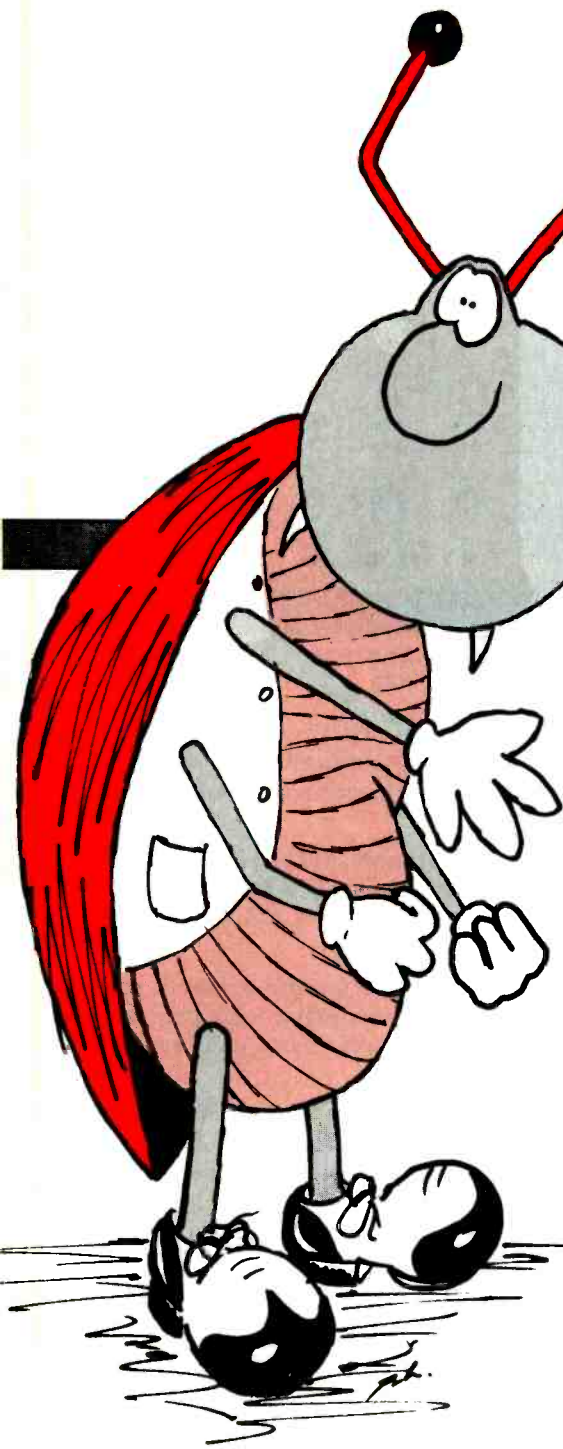

There are electronic bugs, and there are bugs that bug electronics. Technicians are trained to cope with the electronic type, but, according to a national pest control consultant, the insect-type bugs have put the electronic equipment community between the well-known rock and the hard place.

"The dilemma stems from the threat of insect invasion of computers, cash registers, security alarms and other high-tech instruments," says Russell E. Jones, president of Rainbow Manufacturing Corporation, a firm that specializes in pest control research and products.

On the rock side: Electronics equipment is vulnerable to various insect-caused malfunctions. Hard place? Conventional insecticides are unsuitable for application inside electronic housings. Many aerosol insecticides, in fact, carry the cautionary statement: Do not use on plastics, painted or varnished surfaces; do not spray directly into any electronic equipment . . .

Consider that manufacturers' warranties and dealer service contracts do not cover damage due to insects. Because of this, insect invasion, although not epidemic, may be a problem to the owner of infested equipment even if the "infestation" is limited to a single roving roach. Perhaps the most devastating incident of this type occurred in a New York hospital.

According to Jones, a roach got into an \$800,000 computer system and crossed a high-voltage contact. This caused a short that was accompanied by a huge puff of smoke which, in turn, activated an automatic sprinkler system. The computer quite literally was washed up.

Far less costly, though annoying and disruptive, was a spider's invasion of a personal computer in a Maryland school superintendent's office. The critter's web shorted out the twin-diskette model's B-drive. Service and parts cost about \$250. Had the operator not had a back-up disk, her recording time would have been wasted and valuable information lost.

Automatic smoke and heat detectors have been a favorite attraction for flying and crawling insects for many years. On Nantucket Island, off Massachusetts, insects were the primary cause of the hotel-motel industry's disconcerting false alarm wave in 1984. Monthly "falsings" numbered as high as 60.

In New Mexico, insects set up housekeeping in a small-town high school's new \$100,000 fire alarm system. One measurement of their destruction is the \$15,000 they cost the community in false alarm fines in a single year.

Electronic cash registers are frequent prey, too. Roaches are the primary marauders, causing circuit board shorting by gnawing the

Now test and restore every CRT on the market . . . without ever buying another adaptor socket or coming up embarrassingly short in front of your customer . . . or your money back



**with the new improved CR70 "BEAM BUILDER"™
Universal CRT Tester and Restorer
Patented \$995**

plastic-coated wiring and depositing their highly acidic feces. In Alabama recently, a food service operator paid \$600 to replace a roach-destroyed board in his \$1,600 cash register.

In California, ants have had a field day in the Department of Transportation's traffic control boxes and other critical cable and wire terminals. Wiring in some boxes had to be replaced twice in three months.

One effective deterrent to insect invasion of electronic equipment is a product called Rainbow Insect-Tape. It is described by Jones as being totally safe for use in electronic equipment because it is non-toxic, non-conductive and non-corrosive. It has been used for more than a decade by Bell Systems and independent telephone companies to keep their outdoor cable closures insect-free. The product has an effective life of up to three years.

InsectTape resembles a BandAid. It comes in 1" x 4" strips of multi-layered plastic compressed to 1/32-inch thick. It contains a sealed-in reservoir of high-strength propoxur (Baygon), which continually migrates to and crystallizes on the tape surface. The peel-and-stick strips are easy to apply.

Additional information, safety data and allied laboratory reports are available. . .

Circle (131) on Reply Card

Have you ever?

Thrown away a good TV CRT, data display CRT, or scope CRT that could have been used for another two or three years because you had no way to test or restore it?

Lost valuable customers because you advised them that they needed a new CRT when another technician came along and restored the CRT for them?

Lost the profitable extra \$35 or more that you could have gotten for restoring a CRT while on the job and locked in the profitable CRT sale later?

Avoided handling profitable trade-ins or rentals because you were afraid you'd have to replace the picture tube when you could have restored it?

Had a real need to test a CRT on the job, but didn't have the right adaptor socket or setup information in your setup book?

If any of these things have happened to you, **CALL TODAY, WATS FREE, 1-800-843-3338**, for a **FREE 15 day Self Demo**.

"BEAM BUILDER" is a trademark of Sencore, Inc.



Call Today Wats Free 1-800-843-3338

SENCORE

**3200 Sencore Drive
Sioux Falls, SD 57107
605-339-0100 In SD Only**

*innovatively designed
with your time in mind.*

Circle (19) on Reply Card

Test your electronic knowledge

By Sam Wilson

The wide variety of subjects in this quiz makes it very difficult to get a passing grade. Only a super tech will get better than 70% on this one.

1. For a highly stable transistor oscillator, a high

- A.) L-C ratio is desired in the tuned circuit. In other words, the higher the value of L/C, the less likely the oscillator is to drift off-frequency when the temperature changes.
- B.) C-L ratio is desired in the tuned circuit. In other words, the higher the value of L/C, the less likely the oscillator is to drift off-frequency when the temperature changes.

2. The symbol in Figure A is for

- A.) a programmable UJT (PUT).
- B.) an adjustable shunt regulator.
- C.) an SCR.
- D.) a light suppression diode.

3. Figure B shows a vertical antenna in series with a loading coil. Replacing the coil with a short circuit will cause the antenna to have

- A.) higher resonant frequency.
- B.) lower resonant frequency.

4. The circuit in Figure C is best described as a

- A.) follower.
- B.) low-pass filter.
- C.) integrator.
- D.) differential amplifier.

5. When you are dealing with fast TTL logic, the rule is that unused pins should be

- A.) connected to a logic high.
- B.) floating.
- C.) connected to a logic low.
- D.) connected to either high or low.

6. Which of the following statements is correct regarding op-amp filters?

- A.) A unity-gain active filter must be a low-pass filter.
- B.) Unity-gain filters can be either low-pass or high-pass types.
- C.) A unity-gain filter must be a high-pass filter.

7. The maximum rate of change of the output voltage for a step voltage applied at the input is the definition of

- A.) roll off.
- B.) pitch rate.
- C.) slew rate.
- D.) differential margin.

8. Which of the following is a non-inductive winding?

- A.) Fixed Q
- B.) Bifilar
- C.) Shorted-end
- D.) Surge-limiting

9. Which of the following could be

used to measure the voltage of a battery without drawing current from that battery?

- A.) An oscilloscope
- B.) A digital voltmeter
- C.) A potentiometer
- D.) A slide wire bridge

10. In the binary addition problem shown in Figure D, the mistake is in the column marked

- A.) W.
- B.) X.
- C.) Y.
- D.) Z.
- E.) (There is no error.)

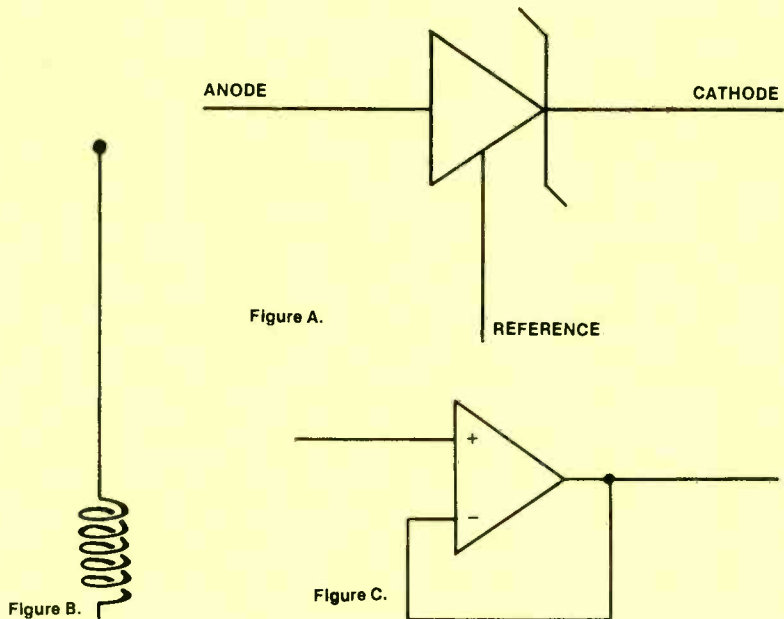

				z	y	x	w
1	1	0	0	1	1	0	0
1	0	1	0	1	0	1	0
1	0	1	1	1	1	1	0

Figure D.

Answers are on page 59

Books

Electronic Servicing Data & Procedures, by Robert C. Genn, Jr.; Prentice-Hall, 373 pages, \$24.95, hardbound.

Today's service technician must analyze and repair an incredible variety of display and solid-state circuits from optoisolators to phototransistors. This up-to-date, fully illustrated service manual provides nearly 200 tests and measurements for troubleshooting, analyzing and repairing a wide range of electronic equipment.

Published by Prentice-Hall, Inc., Englewood Cliffs, NJ 07632; 800-223-2336.

Understanding Solid-State Electronics, by Don Cannon; Howard W. Sams, a division of Macmillan, Inc., 272 pages, \$14.95 softbound.

This is an addition to the Sams/Texas Instruments Understanding Series. It is an easily understood, fully illustrated text that provides self-paced instruction beginning with a review of IC technology and logic circuits. Other topics covered include: logic cells and arrays, microprocessors, digital signal processing, graphics processors, communications processors, bit-slice systems, linear integrated circuits and interface integrated circuits.

Published by Howard W. Sams & Company, 4300 W. 62nd St., Indianapolis, IN 46268; 317-298-5409.

Channel Master Satellite Reception Equipment Service Manual; Channel Master, division of Avnet, 180 pages, \$15, hardbound loose-leaf.

The manual contains information on problem solving, including schematics and a troubleshooting guide. It also has information on adjustments and alignments for best performance. There is a reference for parts that are field-replaceable and should not require special equipment to replace or retune.

Published by Channel Master, P.O. Box 1416, Industrial Park Drive, Smithfield, NC 27577; 919-934-9711.

Walk "tough dog" troubles out of any TV & VCR in half the time . . . or your money back

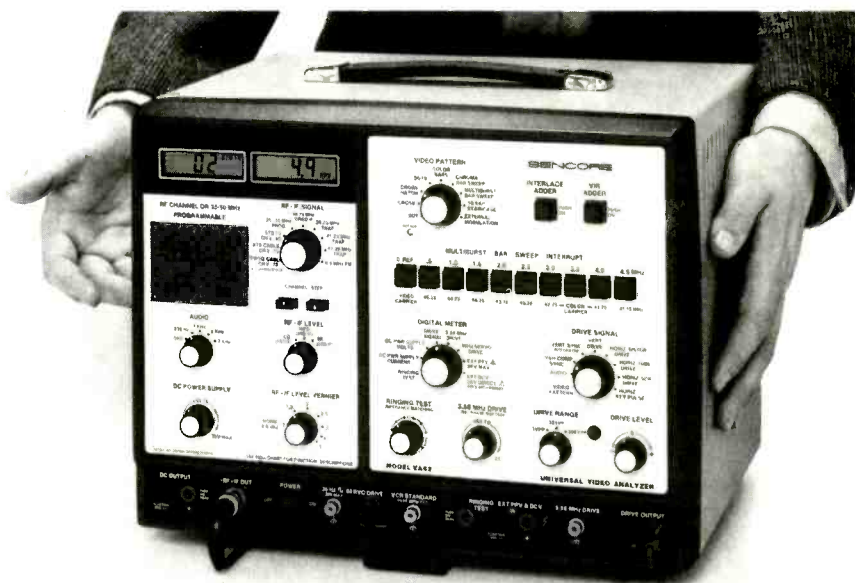

with the exclusive, patented,
VA62 Universal Video Analyzer . . . \$3,295

Would you like to?

Reduce analyzing time: Isolate any problem to one stage in any TV or VCR in minutes, without breaking a circuit connection, using the tried and proven signal substitution method of troubleshooting?

Cut costly callbacks and increase customer referrals by completely performance testing TVs & VCRs before they leave your shop? Own the only analyzer that equips you to check all standard and cable channels with digital accuracy? Check complete, RF, IF, video and chroma response of any chassis in minutes without taking the back off the receiver or removing chassis plus set traps dynamically right on CRT too? Simplify alignment with exclusive multiburst pattern?

Reduce costly inventory from stocking yokes, flybacks, and other coils and transformers, for substitution only, with the patented Ringing Test. Run dynamic proof positive test on any yoke, flyback, and integrated high voltage transformer . . . in- or out-of-circuit?

Protect your future by servicing VCRs for your customers before they go to your competition? Walk out "tough dog" troubles in any VCR chrominance or luminance circuit — stage-by-stage — to isolate problems in minutes? Have proof positive test of the video record/play heads before you replace the entire mechanism?

Increase your business by meeting all TV and VCR manufacturers' requirements for profitable warranty service work with this one universally recommended analyzer?

To prove it to yourself, CALL TODAY, WATS FREE, 1-800-843-3338, for a FREE Self Demo . . . or learn how the VA62 works first by calling for your free simplified operation and application instruction guide, worth \$10.00.



Call Today Wats Free 1-800-843-3338

SENCORE

3200 Sencore Drive
Sioux Falls, SD 57107
605-339-0100 In SD Only

*innovatively designed
with your time in mind.*

Circle (20) on Reply Card

Are you ready for multistandard TV?

There currently are 11 major TV transmission standards in use around the world (each country selects its own). A conventional color TV set (CTV) is compatible with only one standard, and can't receive the broadcasts of other standards.

Color TV sets that can receive signals of more than one standard have been needed, especially in Europe and the Middle East, where different transmission standards (PAL and SECAM) operate in close proximity. Moreover, the increasing availability of video cassette recorders (VCRs) and videodisc players, as well as video software (prerecorded programs), has spurred demand for multistandard CTVs.

**...some 10 million
CTV sets...will soon be
multistandard models.**

Using these multistandard CTVs, viewers can enjoy video software recorded in other countries under different transmission standards. (Many of them are in NTSC or modified NTSC standard.) For this reason, some 10 million CTV sets out of the 60 million (estimated annual worldwide demand for 1986) will soon be multistandard models.

A current multistandard CTV set may use seven integrated circuits (ICs) for automatic detection of transmission standards and signal processing, with about 500 peripheral component pieces.

Two advanced LSI (large-scale integration) chips recently developed by Toshiba can reduce the number of components to 250, simplify the CTV production process, and improve the flexibility of chassis design. Moreover, the chips can perform a variety of functions, such as teletext, for the higher-end CTVs.

According to Toshiba, the TA8616N is the world's first

achievement of a one chip multistandard video-chroma-deflection combination. It integrates 3,800 elements on a 5.2mm x 5.4mm chip—the world's largest integration for a bipolar device—with a DIP shrink 64-pin package.

The second chip (TA8615N) is used in conjunction with the TA8616N. It integrates 550 elements on a 2.4mm x 2.5mm chip in a DIP shrink 30-pin package.

This article was based on information provided by the Toshiba Corporation.

CALL TOLL FREE
Include work address and
phone number for Free Catalog.

800-824-2873

SCOPES

IWATSU



- All 14 models in stock
- 2-3 year warranties
- 20-250 MHz

MODEL	PRICE
5702	\$ 535
5705	\$ 899
5710	\$1245
5711	\$1695
5706	\$ 749

HITACHI V-222

Portable Dual Trace Scope

SALE \$535

LIST \$715⁰⁰

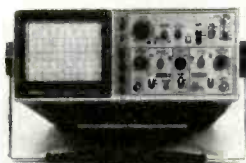

- DC-20 MHz
- 3-Way Power Supply
- Lightweight
- High Sensitivity and Fast Sweep Timer

HITACHI Hitachi Denshi America, Ltd.

- All 20 models in stock
- 2-3 year warranties
- 20-100 MHz

MODEL	PRICE
1050	\$1299
509	\$1199
VC6041	\$4400
422	\$ 690
1100	\$1900
650	\$ 930
V209	\$ 725
1070	\$1595
1100A	\$2490
V222	\$ 550

DIGITAL MULTIMETERS

BECKMAN

Beckman Industrial™

- All 300, HD, and Circuitmate series
- All accessories in stock

MODEL	PRICE
HD100	\$169
HD110	\$189
HD130	\$239
HD140	\$259
300	\$120
310	\$145
320	\$179
330	\$219
350	\$229
360	\$289
4410	\$239

FLUKE

- Autorange
- Touchhold function
- 0.3% accuracy
- Heavy duty Analog display

MODEL	PRICE	MODEL	PRICE
73	\$ 79	75	\$ 99
21	\$ 99	23	\$145
25	\$229	27	\$259
8010A	\$279	8012A	\$359
8020B	\$199	8022B	\$154
8024B	\$249	8050A	\$389

FLUKE 77

SALE

\$114

LIST \$139⁰⁰

Analog/Digital
Multimeter



POWER SOURCES

POWER DESIGNS

- Low and high voltage power sources
- 1-5 year warranties

MODEL	PRICE
2020B	\$750
2K20	\$695
4050	\$660
6150	\$725
TW5005W	\$595
TW6050A	\$880
TW347	\$695
TP340	\$750
TP343A	\$795

**USED TEST EQUIPMENT, TOO!—OVER 3,000 MODELS
AVAILABLE AT HUGE DISCOUNTS WITH WARRANTIES!**

■ Quantity Discounts Available ■ Dealers Welcome ■ Freight and Tax Extra ■ Immediate Availability of Equipment

**US United States
Instrument Rentals, Inc.**

A U.S. Leasing Company
2988 Campus Drive
San Mateo, CA 94403

Circle (21) on Reply Card

What do you know about electronics?

A letter about sawtooth waveforms

By Sam Wilson

Dear Sam:

I am an electronics technician with many years in the field. I have managed to keep pace with the ever-growing field of electronics.

As I was reading the recent issue of *Electronic Servicing & Technology* (August 1986), I came across an article on "Tests for Low-Frequency Amplifiers." In it you requested an answer as to why technicians seldom use the sawtooth waveform test. I am pretty sure that many technicians will agree with what I am about to say.

First, out of all the service station facilities, how many have a spectrum analyzer? A few, if any at all. This is an elaborate piece of equipment with an expensive price tag. If a facility has such an item the supervisor stresses that no one is to touch it except supervisory personnel—that is, if it is touched at all. The spectrum analyzer might be sitting in some location gathering dust.

If technicians were allowed to use this piece of equipment, how many know *how* to use it and would instruct other technicians accordingly?

Secondly, while servicing a piece of audio equipment, the technician's objective is to repair it as quickly as possible so that sound comes out of it. He is not allotted the time to sit around and read the odd numbers of harmonics present, except in his spare time.

I read the issues of *Electronic Servicing & Technology* and I find it informative. This tip on tests for low-frequency amplifiers has given me a new piece of infor-

mation that makes me more aware of a new problem that can exist in amplifiers.

Thomas Velez

My answer:

Dear Mr. Velez:

Thank you very much for taking the time to write. Somehow, we got on different wavelengths regarding the sawtooth test. If you look at the article, you will notice that I compared the sawtooth test with the square wave test. They both have the same test set-up and *no spectrum analyzer is needed.*

Figure 1 shows this simple test set-up. The sawtooth generator takes the place of the square wave generator. It applies the sawtooth waveform to the amplifier input terminals. The oscilloscope is connected to the amplifier output terminals. If the amplifier has a broad frequency response, there will be no change in the observed output sawtooth waveform.

You can look at the sawtooth waveform in two different parts as

shown in Figure 2. Part A represents a relatively gradual change in voltage from the minimum to the maximum value. The low-frequency response of the amplifier is being tested by this gradual change in voltage.

The second part of the sawtooth is a very rapid change from maximum to minimum. This is marked (B) on the drawing and it tests the amplifier high-frequency response. As was stated in the article, the sawtooth is made up of a number of harmonic waveforms. A poor high-frequency response will cause this line to be a curve rather than a straight drop to minimum value.

Figure 3 shows four of the basic sawtooth outputs in an amplifier test. As with the square wave test, this is just a quick method of checking an amplifier's overall response. It is a *qualitative* test and requires the technician's experience to interpret the output waveforms.

The test is more useful if the sawtooth goes above and below 0V

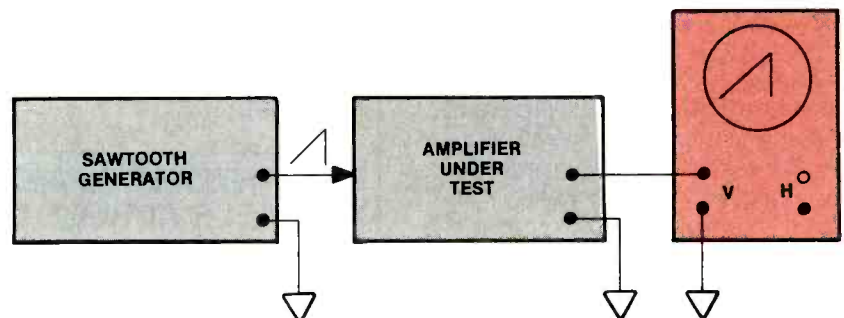

Figure 1. Frequency response of an amplifier can be tested by connecting it to a sawtooth generator and an oscilloscope as shown here.

by equal amounts as shown in Figure 4. That permits both cut-off and saturation observations.

As in the case of the square wave test, it would be a good idea to check the scope first to see if it is able to handle the sawtooth before the amplifier gets involved in the analysis.

Again, thank you for writing.

Applications of the Hall Effect

As technicians, you should be familiar with the Hall Effect and some applications of this effect.

Figure 5 shows the basic principle involved. This is a model showing the relationship among current, voltage and magnetic flux in the Hall device.

In the absence of any external flux, the current flowing through the semiconductor slab would be equally distributed and there would be no difference in voltage between the two edges. When a flux is introduced, the charge carriers in the semiconductor slab

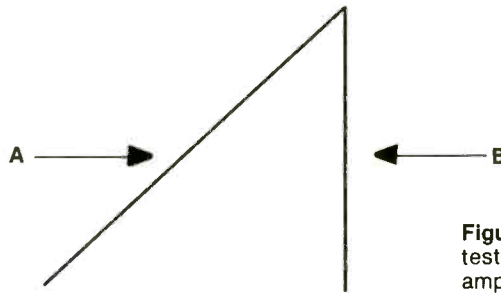

Figure 2. The leading edge of a sawtooth tests the low-frequency response of the amplifier under test. The trailing edge of the waveform tests the high-frequency response.

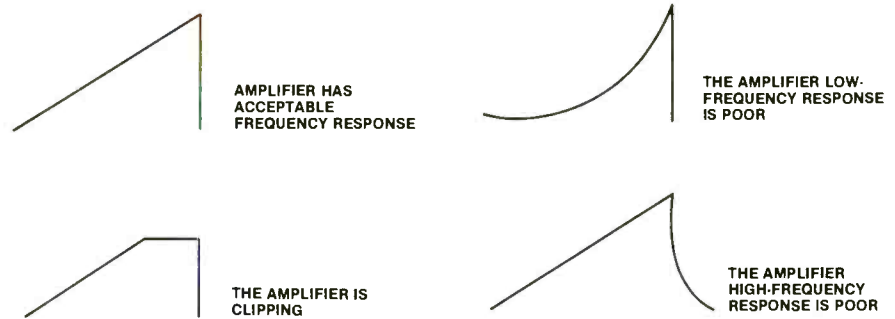

Figure 3. The scope trace of the amplifier's output will be a good indication of the frequency response.

Tired of fishing through microfiche files for service data?

Then the new three-volume set of Hitachi VCR Schematic Manuals is for you. Not only do these easy-to-use manuals offer you the compact storage of 32X microfiche but also provide you with hard copy of those items you use most

- Schematic Diagrams
- Block Diagrams
- Printed-Circuit Board Layout
- Part Locations
- Mechanical Part Exploded Views

Volume 1: 1978-1980 Covers Eight VT Models: 4200, 5000, 5600, 5800, 8000, 8500, 7000/VT-TU70, 7500/VT-TU75

Volume 2: 1981 Covers Five VT Models: 9100, 9500, 9700, 9710, 6500/VT-TU65

Volume 3: 1982-1983 Covers Twelve VT Models: 11A, 11AR, 12AY, 12AX, 15A, 16A, 16AY, 18A, 19A, VT-680MA, VT-6800, VT-TU68A

The price of these manuals is unbelievably low. Each volume contains not one model but many.

All for \$49.95. Or get all three with a total of 25 models for \$139.95. Less than \$6.00 per model.



HITACHI SALES CORP. OF AMERICA
Publication & Service
Support Division

Call toll-free 1-800-447-2882 for your local distributor:

**ELENCO PRODUCTS
AT DISCOUNT PRICES!**

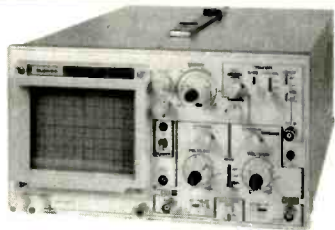

20 MHz Dual Trace Oscilloscope
\$349.95 MO-1251
 Two 1x, 10x 100 MHz probes, diagrams and manual included. Write for specs.
 35 MHz \$499.95 MO-1252

**GF-8016 Function Generator
with freq. counter**



\$219.95

Sine, Square, Triangle
 Pulse, Ramp, .2 to 2 MHz
 Frequency .1 thru 10 MHz

GF-8015 without freq. meter \$169

Triple Power Supply XP-660

0-20V @ 1A
 0-20V @ 1A
 5V @ 5A



\$149.95

Fully regulated, short circuit protected with 2 limit cont. 3 separate supplies

3 Amp Power Supply XP-650



0-40V @ 1.5A
 0-20V @ 3A

\$119.95

Fully regulated, short circuit protected current limit control

Color Convergence Generator



SG-200
\$69.95

Finest in the industry
 10 rock steady patterns

**Multimeter with Capacitance
and Transistor Tester**

Model CM-1500

\$64.95

Reads volts, ohms, current,
 capacitors, transistors, diodes



Digital LCR Meter

\$148.95



Model LC-1800
 Measures: Inductors
 Capacitors, Resistors
 Inductors .1uH to 200H
 Capacitor .1Pf to 200uF
 Resistor .01 Ohms to 20M Ohms
 Ranges 6 Ind, 7 cap, 7 res

C&S Sales, 8744 W North Ter.
 Niles, IL 60648 800-292-7711
 312-459-9040 ASK FOR CATALOG
 Add 5% P&H (\$10 Max per item)
 IL Res., add 7% sales tax



Circle (23) on Reply Card

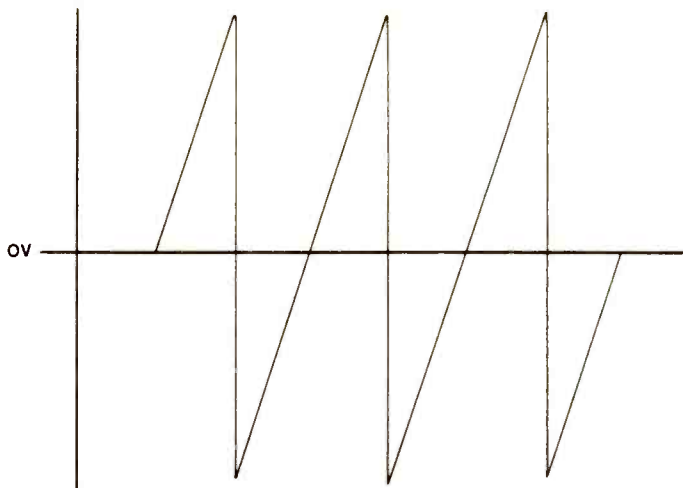

Figure 4. The sawtooth waveform test is more useful if the sawtooth goes above and below 0V by equal amounts, permitting both cut-off and saturation observations.

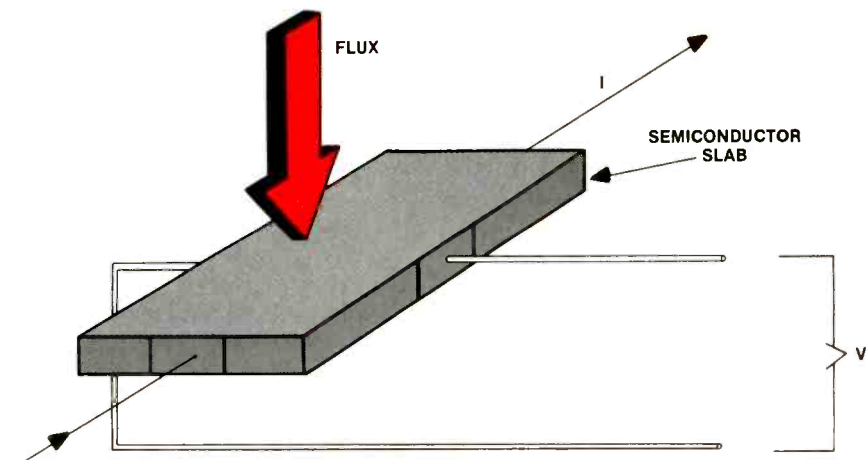

Figure 5. In a Hall effect device, when there is no magnetic flux present, the voltage across the two edges is zero.

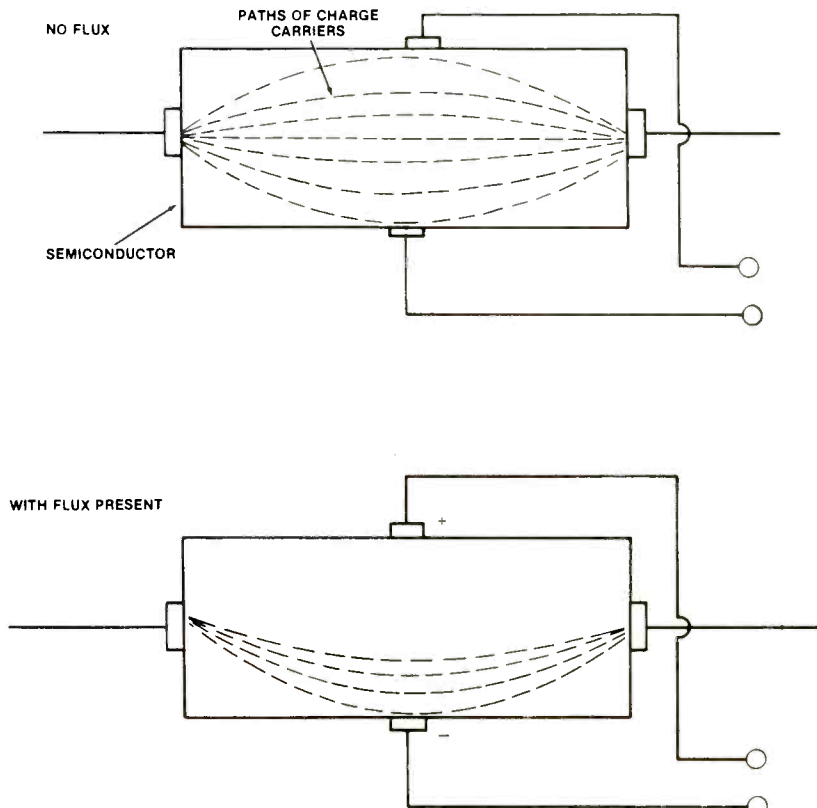

Figure 6. Introduction of a magnetic flux causes a redistribution of charge carriers in the Hall effect material that results in a voltage difference across the device.

A.W. Sperry Instruments introduces The 4½ digit DMM with the 3½ digit price.

Another A.W. Sperry Instruments first! Our new **AWS DM-7010** combines the precision of 4½ digit readings with all the most-wanted features you've been looking for. We've even included a built-in frequency counter (up to 200KHz)! With 9 functions and 33 ranges, the **AWS DM-7010's** expanded capability can't be beat!

And that's not all! Included among the special functions built into the **DM-7010's** small, self-contained housing are: conductance, diode test and an instant audible continuity check. The **DM-7010** has a basic DC Volt accuracy of 0.05% and loads of built-in safety features.

You'd expect to pay \$300 or more for an instrument boasting this kind of performance, yet the **AWS DM-7010** can be yours for a low **\$170!** Now there's no need to pay more for the accuracy and quality you need in a DMM.

For more information, call your distributor or A.W. Sperry Instruments, Inc., P.O. Box 9300, Smithtown, N.Y. 11787. **800-645-5398 Toll-Free** (N.Y., Hawaii, Alaska call collect 516-231-7050).

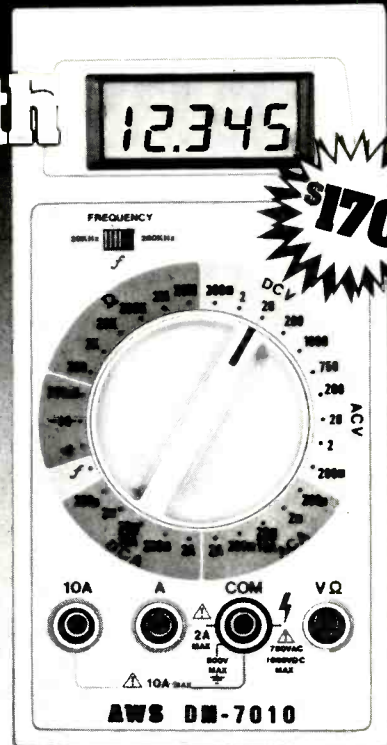

A.W. SPERRY INSTRUMENTS INC. The Measurable Advantage.

Circle (24) on Reply Card

tend to move around the magnetic field. (See Figure 6.) That produces a greater concentration of flux on one side than on the other.

The greater concentration of charge carriers on one side means that there is a voltage difference between the edges. This is the output voltage of the Hall device. Increasing the flux produces an increase in the output voltage for a given amount of current flow.

One obvious application of this device is in the measurement of magnetic field strength. The output voltage can be calibrated to indicate the exact amount of flux when the current is held to a constant value.

It also is possible to determine the current with this device. This application is shown in Figure 7. The soft iron material around the current-carrying conductor concentrates the flux on the Hall device. The voltage output is dependent upon the amount of flux that, in turn, is dependent upon the amount of current. Therefore,

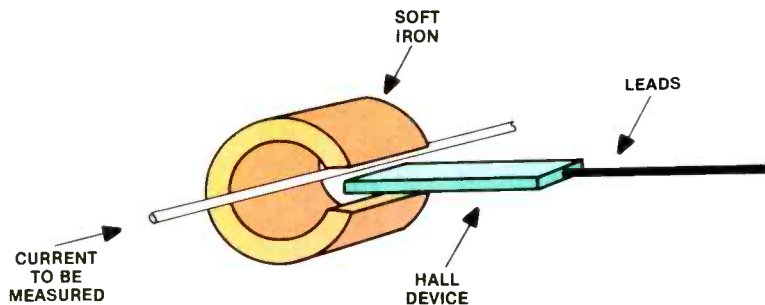

Figure 7. A Hall effect device can be used to measure the current in a conductor by measuring the magnetic flux induced by the current.

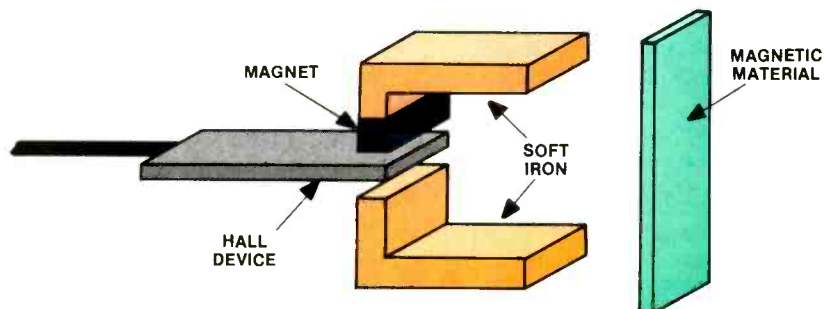

Figure 8.

Figure 8. Through use of a permanent magnet, a Hall effect device can be used as a motion detector.

Capacitance, logic and more. For less.

Now, a fully-loaded DMM combines a capacitance meter, logic probe, and an hFE meter, all for the price of a DMM.

- TTL Logic Probe: 20 MHz
- Hi/lo/off indications
- Detects 25nS pulse width
- Capacitance: 5 ranges (2nF to 20 μ F)
- hFE (NPN or PNP): 1 range (1000)
- DMM: DCV-5 ranges (.2V to 1kV)
- ACV-5 ranges (.2V to 750V)
- DCA-4 ranges (200 μ A to 10A)
- ACA-3 ranges (20mA to 10A)
- Ohms-7 ranges (200 Ohms to 2000 Megohms)
- Continuity beeper
- Diode check
- Built-in bail
- Anti-skid pads

See one now at your local Beckman Industrial distributor.

DM25L... \$89⁹⁵*



*Suggested list price (\$US) with battery, test leads and manual.

Beckman Industrial™

Beckman Industrial Corporation
A Subsidiary of Emerson Electric Company
630 Puente Street, Brea, CA 92621
(714) 671-4800

© Copyright 1985 Beckman Industrial Corporation

Circle (10) on Reply Card

the current can be determined by measuring its accompanying magnetic field. There is no need for breaking the current line.

Figure 8 shows the use of a Hall device for sensing position and motion. It requires a strip of magnetic material. This material can be attached to a moving or stationary surface. Magnetic flux is supplied by a permanent magnet. As the magnetic material approaches the Hall measuring device, there is an increase in flux through the semiconductor material. That increase in flux produces an increase in voltage.

The output voltage can be sensed and used to control the motion or position. With this system, it is possible to measure movements and positions within 0.001 inch.

I am grateful to F.W. Bell Inc., Columbus, OH, for supplying the information on the Hall Effect and its application.

The technology required to produce a compact disc

In the next issue, there will be a discussion on some of the circuits involved in making a compact disc. I decided it would be a good idea to reflect on the problem of making the compact disc work before we get into the circuitry.

Think first about the disc itself. It is about 4 $\frac{3}{4}$ inches in diameter, and it can play up to 60 minutes. On the recorded side of the disc there are approximately 2 $\frac{1}{2}$ miles of spiral track. Just getting tracks that are so closely spaced is, by itself, a technological marvel.

In order to get such a long groove, it is necessary to keep the distance between the spiral tracks a constant at 1.6 μ m.

It is necessary for the disc to be very flat. A long-playing record can have a warp of as much as 1 $\frac{1}{2}$ mm and still be playable, but the disc must be flat to within 0.4mm. (This is not as hard as might be thought since the disc is much smaller and more rigid than the large LP records.) The information stored in the disc is in the form of pits and lands. The width of a pit is about 0.4 μ m and its depth is about 0.1 μ m. These very small bumps in the track of the

disc represent logic ones and zeros for stored information.

A laser beam is used to retrieve the information from the disc. During playback, the laser beam starts at the inside track and works outward.

If that disc is turning at a constant speed, it would mean the rate of input information would be greater near the outer edge. However, in practice, the disc is scanned at a constant linear rate of about 1.3m per second. To accomplish this, the disc has to be turned faster at the inside and slower at the outside track. At the start-up, the disc turns at about 500RPM. Toward the outside rim, the speed is automatically slowed to about 200RPM. The overall result is that the laser disc moves at a constant linear speed on the track.

By linear speed, I mean the speed of the stylus on the surface of the disc. Keeping the laser beam focused in the track requires some very sophisticated technology.

The beam must be focused precisely. Also, some provision must be made so that if the laser starts to get off the track, an immediate correction will be made.

The necessary circuitry for laser tracking involves the use of four light-sensing diodes. The physical position of these diodes depends upon the company making the compact disc player. The overall result is that the diodes and associated circuitry can refocus the beam if it gets out of focus, and it can recenter the beam if it starts to get off the track.

During the recording process, the sound is converted into a series of digital numbers. During playback over 44,000 numbers, each 16 bits wide per channel, are retrieved per second. The technology used to do this produces 4 million switching operations each second.

The pits and flats that represent the sound are not on the surface of the disc, but rather, are about 1.1mm below. A transparent covering protects the surface.

The present technique is to read the disc upside down. In other words, the grooves are read from the bottom of the spinning disc.

More next month.

ES&T

**WE MAKE
START UP / SHUT DOWN**

**“DEAD SET”
PROBLEMS**

**THE FASTEST, EASIEST
MOST PROFITABLE**

JOBS THAT EVER REACH YOUR BENCH

- - - So, why are **YOU** still struggling for hours and hours when you repair them?

Our **Mark V** will take you to specific defective “circuit” level in minutes, at the push of a button, for only \$795⁰⁰. In just 30 days, the Mark V can make you enough extra profit to purchase a Mark VII-E!

Our Mark VII-E will take you all the way to the specific defective “component,” tell you whether the defective component is open or shorted, tell you how the defective component has affected the operation of the overall circuit, and give you a single “landmark” test point to measure that will prove its finding to be 100% accurate. The Mark VII-E does all of the above in just one/one hundredth of one second, at the push of one button, for only \$3,495⁰⁰.

The Mark VII-E will also isolate “intermittants” while you play golf!



**VISA / MASTERCARD
WELCOME**



DIEHL INDUSTRIES

6661 Canyon Dr. “D” • Amarillo, TX • 79110

Phone (806) 359-0329

Back in October when I turned *on* the heating system in my home for the first time during this heating season, it immediately became apparent that something was wrong. The blower came *on* at high speed as soon as the COOL-OFF-HEAT switch was placed in the HEAT position. The AUTO-ON switch was in the AUTO position. The correct behavior of the system is to pause for a minute or two once the system has been activated while the gas flame heats the air in the heat exchanger to some predetermined temperature. Once that temperature is reached, the blower comes *on* at low speed and gently distributes warmed air throughout the house. What was in fact happening was the blower came *on* at high speed immediately when the system was turned *on*.

I'm not a gas furnace expert, but when the heating company wasn't able to come out for a week because of a rash of service calls, I decided to take a crack at the problem.

Fortunately there's an electrical block diagram glued to the furnace door. Armed with that and my multimeter, I decided to try to track down the source of the problem. I found the trouble to be associated with a relay. The normally closed contacts in the relay connect the blower motor's low speed windings through the heat exchanger thermostat. When the relay is energized, the normally closed contacts open and the normally open contacts close. In this configuration, normally occurring when the thermostat is placed in the *ON* position, the blower motor's high-speed windings are continuously connected and the blower blows at high speed regardless of the condition of the heat exchanger thermostat.

After I had studied the circuit diagram for a while it became clear that either the thermostat ON-AUTO switch when placed in the *AUTO* position was sending a spurious signal to the relay, or the relay was stuck in its energized position. It turned out to be a problem at the thermostat.

Troubleshooting a microcomputer-based control system proceeds in a manner similar to troubleshooting this relay-based control system. The microcomputer circuit may be viewed as a complex relay circuit. In the relay, an input signal causes an output, which in turn initiates some action. In the microcomputer circuit, an input signal, or a combination of input signals, causes an output at another terminal of the microcomputer, which in turn causes some action.

That fact should strip away some of the mystery surrounding microcomputers in consumer electronic products. They're tiny and contain a lot of circuitry that only the designers understand, but the thing a servicing technician is concerned with is the *inputs and outputs*.

A VCR microcomputer control system

Take a look at Figure 1, a microcomputer control diagram from a GE VCR. Notice that some of the terminals of the microcomputer are inputs and some are outputs.

Let's take a specific sequence of events and consider how to troubleshoot if it doesn't occur as it should. When you insert a cassette into the front of the machine, it should be automatically loaded by the front-loading motor, then it should stop once it's in position and await a signal from the control panel. If the cassette doesn't load, what's the problem?

Take a look at the upper left of the diagram. When you insert the cassette, the CASSETTE IN switch should close bringing PIN 7 low. This input to the microcomputer should result in outputs that drive the front-loading motor, which in turn moves the cassette into the down position. Once the motor is loaded, the CASSETTE UP/DOWN

switch closes, sending a signal to the front-loading motor to halt.

If this sequence of events doesn't occur, the problem could be anywhere in the chain that connects the CASSETTE IN switch with the F. LOADING motor. It could be the switch itself, or a poor connection from the switch to ground, or from the switch to the microcomputer. On the output side, (look at the lower right side of the diagram), the problem could be a burned out motor, a faulty plug, problems in IC 6002 (the motor driver) or any of the interconnections between any of these elements.

Notice that no mention was made of the microcomputer itself. It could have been that, of course, but conventional wisdom, for the time being at least, is that the microcomputer is highly reliable and is the least likely to be the cause of the problem. Check the microcomputer last. The troubleshooting flowchart (Figure 2) shows how you should proceed.

Table model VCRs

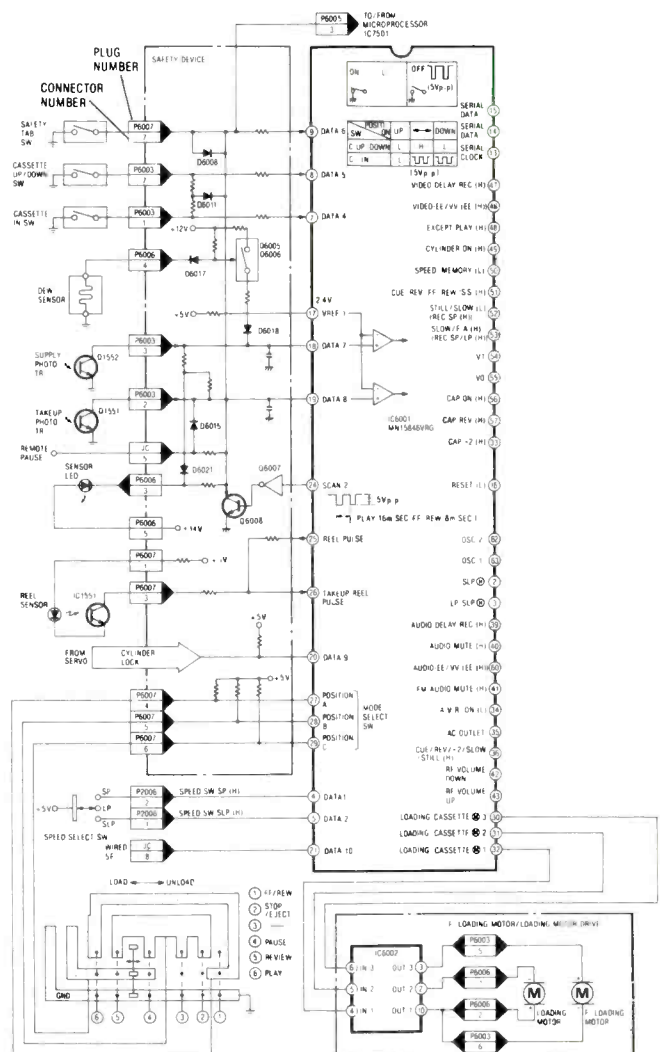

Figure 1.

**TROUBLESHOOTING
SYSTEM CONTROL**

CHECK THE OUTPUT LOGIC STATES FROM THE SYSTEM CONTROL MICROPROCESSOR. DO THEY RESPOND CORRECTLY TO OPERATIONAL INPUT COMMANDS?

NO → CHECK THE TROUBLE LINE INPUTS AND MECHANICAL STATE SWITCH INPUTS AT THEIR SOURCE (AS FAR AWAY FROM THE MICROPROCESSOR INPUT PINS AS POSSIBLE). ARE THESE CIRCUITS OPERATING CORRECTLY?

YES → CHECK THE CIRCUITRY THAT TRANSFORMS THESE OUTPUT COMMANDS INTO DRIVE VOLTAGES (FOR MOTOR) AND LOGIC LEVELS (FOR ELECTRICAL CIRCUIT SWITCHING).

NO → TROUBLESHOOT THE DEFECTIVE CIRCUIT.

YES → USE THE OSCILLOSCOPE TO CHECK THE OPERATIONAL INPUT KEY MATRIX. ARE OPERATIONAL INPUT PULSES BEING RETURNED TO THE MICROPROCESSOR WHEN COMMAND BUTTONS (PLAY, RECORD, FF, ETC.) ARE PUSHED?

NO → TROUBLESHOOT THE OPERATIONAL INPUT KEY MATRIX STAGE.

YES → USE THE OSCILLOSCOPE TO CHECK THE TROUBLE LINE, MECHANICAL STATE, AND OTHER "TIME SHARED" INPUTS TO THE MICROPROCESSOR, ARE THESE INPUTS CORRECT?

NO → TROUBLESHOOT THE DEFECTIVE CIRCUIT.

YES → SUSPECT A DEFECTIVE MICROPROCESSOR.

NO → TROUBLESHOOT THE DEFECTIVE CIRCUIT.

YES → SUSPECT A DEFECTIVE MICROPROCESSOR.

NO → TROUBLESHOOT THE DEFECTIVE CIRCUIT.

YES → SUSPECT A DEFECTIVE MICROPROCESSOR.

NO → TROUBLESHOOT THE DEFECTIVE CIRCUIT.

YES → SUSPECT A DEFECTIVE MICROPROCESSOR.

NO → TROUBLESHOOT THE DEFECTIVE CIRCUIT.

YES → SUSPECT A DEFECTIVE MICROPROCESSOR.

Figure 2.

Follow a similar procedure for other trouble symptoms, keeping in mind that in many cases you have to consider multiple inputs. For example, if the cassette loads correctly but pushing the PLAY button doesn't result in a picture on the screen, it could be one of many things: the loading motor might not have operated properly, or IC 6002 might be faulty, or the switch that monitors the state of the mechanical components might be faulty.

The microcomputer(s) in any of today's sophisticated consumer electronic products are busy little units, and they make the product seem complicated and difficult to service. But if you just keep in mind that the microcomputer is similar in function to a relay system in that an input or combination of inputs is designed to result in an output, troubleshooting a microcomputer-based control system becomes a logical exercise in tracking where the system broke down.



HIGH VOLTAGE TRIPLERS/MULTIPLIERS

REPLACEMENT FOR

ECG®/GE®/SK®

500A /GE527 & SK3304	8.75	6.95
523 /GE528 & SK3306	8.85	7.20
526A /SK3306	8.85	7.20
528 /SK3906	10.70	8.70
529 /GE529 & SK3307	9.99 3 MIN.	7.95 100 MIN.

OUTPUT TRANSISTORS

165 /SK3115 & GE38	2.25	1.95	1.75
238 /GE37 & SK3710	2.25	1.95	1.75
283 /SK3467	2.75	2.35	1.80
2SD1341P	2.25	1.95	1.75
2SC1172B	2.25 5 MIN.	1.95 50 MIN.	1.55 100 MIN.

AUDIO POWER

TYPE	10 min	50 min	100 min	TYPE	10 min	50 min	100 min	TYPE	10 min	50 min	100 min
152 /SK3893	.30	.25	.21	196 /SK3054	.49	.44	.39	291 /SK3440	.49	.44	.39
153 /SK3274	.30	.25	.21	197 /SK3083	.59	.54	.49	292 /SK3441	.49	.44	.40

RECTIFIER DIODES

125	1000V/2.5A	7c	6c	5c
156	1000V/5A	18c	16c	13c
506	DAMPER/HI-VOLT—FAST RECOVERY	29c	24c	19c

\$\$\$ ADDITIONAL SAVINGS \$\$\$

TYPE	10 min	50 min	100 min	TYPE	10 min	50 min	100 min
102A	.35	.32	.29	171	.49	.44	.38
123A	.18	.16	.14	184	.38	.33	.28
123AP	.13	.11	.09	185	.38	.33	.28
128	.38	.35	.29	198	.60	.54	.49
129	.38	.35	.29	199	.18	.15	.12
130	.59	.55	.49	234	.19	.16	.13
159	.16	.13	.11	375	.44	.42	.39
162	2.25	1.95	1.49	712	.75	.69	.60
163A	2.35	1.99	1.55				

FOR A COMPLETE LIST CALL OR WRITE—C.O.D. Orders Welcome (Min. Order \$25)

DIGITRON ELECTRONICS

110 HILLSIDE AVENUE, SPRINGFIELD, NEW JERSEY 07081

Toll Free 1-800-526-4928 In NJ 201-379-9016 Telex 138441

PRICES SUBJECT TO CHANGE WITHOUT NOTICE. OFFER GOOD WHILE SUPPLY LASTS. ECG is a Trade Mark of Philips ECG, Digitron Ele. not associated with Philips ECG.

Circle (26) on Reply Card

**NESDA
Computer Group**

COMPUTER SALES AND SERVICE DEALERS
WORKING TOGETHER

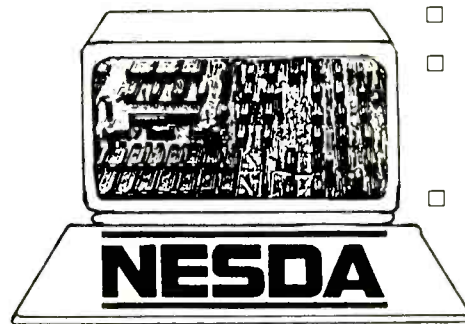

- Service training.
- Assistance in selecting in-house equipment and software.
- Specialized software for service management.

- Factory contacts for service literature and parts.
- Involvement in a stable and productive national trade association.

FOR MORE INFORMATION SEND BUSINESS CARD TO:
NESDA COMPUTER GROUP, 2708 WEST BERRY STREET
FORT WORTH, TEXAS 76109; PHONE (817) 921-9061

Readers' Exchange

For Sale: CRT recovery/tester/short remover, model 201-REM (Torrence, CA), has four meters, built-in timer, adapters, good condition, \$125 or best offer; tube and CRT tester, EICO model 635, used six times, new condition, all information included, \$60 or best offer. Will UPS or c.o.d. Cecil F. Mott III, 221 Mobil Land Court, Bloomington, IL 61701.

For Sale: Sencore PS163 scope, \$150; Sencore VA48, \$750; Sencore CB41 tester, \$100; EICO 667 tube tester, \$100; Sencore DVM56, \$400. Bill Bechtold, 7429 Frederick, Omaha, NE 68124; 402-397-2461.

For Sale: Sencore VA48 with all cables, adapters, manuals and instructional tape, excellent condition, \$650 includes shipping. John B. Schneider, 856 Pedro Ave., No. B, Orlando, FL 32807; 305-281-1293.

Wanted: Old Leader, B&K transistorized oscilloscopes, any condition. Please send model number and asking price. M. Shelton, 2708 May Drive, Burlington, NC 27215.

Wanted: For electronics classes - any type of circuit boards for students to practice with. All are tax-deductible. Walter Williams High School, c/o Mike Shelton, 1307 S. Church St., Burlington, NC 27215.

Wanted: Precision EV10 VTVM, working/non-working; CK300 test jig. State price and condition. Cleo Zarella, 937 Center St., Brockton, MA 02402; 617-583-3667.

For Sale: B&K 1655 ac power supply (isolated variable), \$175; B&K 1801 autoranging frequency counter with PR-25 10:1 probe, \$175; Heathkit IT-5235 yoke/flyback tester with IMA-100-10 100:1 probe, \$40; Heathkit IT-3120 FET/transistor tester, \$25. All equipment includes manuals and leads, all in excellent condition. Tom Finnegan, 2709 S. 18th St., Grand Forks, ND 58201; 701-746-0136.

Wanted: Sams CB Radio volumes: CB28, 56, 57, 67, 68, 74, 75, 79, 80, 81, 82, 85, 86, 87, 88, 89, 91, 92, 93, 94, 95, 96, 101, 102, 104, 105, 106, 108, 110, 118, 120, 124, 128, 131, 132, 133, 135, 137, 147, 159, 160, 236, 240, 243, 244, 245, 246, 247, 248, 252, 254, 255, 256, 257, 258, 259, 260, 261, 262, 263, 265, 266, 267, 268, 272, 273, 274, 275, 276, 278, 279, 281, 282, 283, 284, 285, 287, 288, 289, 291, 292, 293, 294. Paul Garner, P.O. Box 686, Millbrook, AL 36054; 205-285-5839.

Wanted: April 1978 *Electronic Technical Dealer* article that begins on page 20, "Sony and the GCS." McEwen, 4125 Heather St., Vancouver, British Columbia, Canada V5Z 4H1.

Needed: Schematic for Leader oscilloscope, model LB0505; transistor K3491D; schematic and manual for Leader LSW333 sweep/marker generator (or address in New York area where they may be purchased). Joe Varas, 449 Torry Ave., Bronx, NY.

Needed: Transformer part for 1966 or 1967 model Magnavox stereo No. PT3901, serial No. 763649, transformer No. 320310-1. Reginald Huey, 7300 State Ave., Kansas City, KS 66112; 913-334-6391.

For Sale: Picture tube monitor with telematic adaptors, excellent condition, \$35. William J. Maida, 274 W. Sabal Palm Place, Longwood, FL 32779.

For Sale: Sams Photofacts, one each of 1000-3, 1122-2, 1126-3, 1211-3, 1240-1 and 1325-2. Also other complete Sams sets from 10 to 500. Make offer. **Needed:** Sams 908-2, 1070-1, 1166-3, 1283-1 and 1306-2. Will trade for others or will pay for copies. Dan's TV, 316 E. Ave. "E," Hutchinson, KS 67501.

For Sale: Industrial dc-drive service inventory, 25 years of schematics and test jigs. S.a.s.e. for price list and inventory listing. M. Shelton, Box 234, Alamance, NC 27201.

For Sale: Sams Photofact folders No. 822 to 1955, new with nothing missing, 1134 complete folders, \$2 each, not sold separately. Or will sell 822 to 1500 as unit at \$2 each, and 1500 to 1955 as unit at \$3 per folder. Also will sell Ar 19 to 78 sets, 60 issues at \$2 per issue, T.R. 15 to 64 sets, 50 issues at \$2 per issue as complete unit, none sold separately. Test equipment - Sencore FS 135 field meter, \$150; B&K 1076 analyst, \$100; Sencore SM152 sweep and marker, \$200; EICO flyback transformer, yoke tester, \$25; EICO 368 sweep generator and marker, \$25. Prices do not include shipping. **Wanted:** any good short-wave radios and digital frequency counters, Lectrotec scopes such as TO55-TO60, scanners such as Bearcat, working or not. S.a.s.e. for quick reply. Stanley R. Chalker, 1176 Smithsonian Ave., Youngstown, OH 44505.

For Sale: The following Heath items - IG-42 Lab RF generator, 100kHz to 30MHz, \$75; IG-102 RF generator, 100kHz to 110MHz, \$50; IM-18 VTVM, \$50; IR-5204, strip chart recorder, \$100; IO-4235 dual trace, 35MHz scope, \$400; GD-1162 telephone dialer/speaker phone, \$25; IT-2250 autoranger digital capacitance meter, \$75; HD-1250 dip meter, \$50; IM-2215 portable DMM, \$60. Linear-5 sinad meter, new, \$150; Lampkin-109 service monitor, 20 to 42MHz, 150 to 172MHz, 450 to 472MHz, \$500. Simpson - 464 DMM, \$75; 7016 frequency counter, \$75. All guaranteed in working order. Northwoods Electronics, P.O. Box 159, Lac du Flambeau, WI 54538; 715-588-8674.

For Sale: Sencore LC53 Z meter, excellent condition, \$600; Telematic test jig with 30 adapters plus transverter and low voltage focus supply, \$175. Nate Lubenthal, 29515 Quailwood Drive, Palos Verdes, CA 90274; 213-377-9913.

For Sale: EICO model 369 sweep marker generator, complete, \$250; B&K model 467 tube-tester rejuvenator, complete plus extra adapters, \$350. **Wanted:** Schematic or service manual for Emerson model M3070 solid-state AM-FM stereo 8-track cassette tape player. Will copy and return. Information unavailable from Emerson or Sams. D.R. Electronic, David A. Roa, 64 Brown St., P.O. Box 641, Pawtucket, RI 02862-0641; 401-728-0634.

Wanted: Sony TC-770, TC-355 service manuals. Will buy or copy or trade. **Needed:** TC-770 drive motor or complete unit in any condition. **For Sale:** VCR service manuals and tools, send s.a.s.e. HP427A, \$200; HP5381A, \$200. Richard Sereda, 1872 Lexington Ave., San Mateo, CA 94402.

Wanted: Complete kit No. 22T for NRI Master TV Course model 315 25" color television. David M. Kinchlow, 1515 Walnut St., New Albany, IN 47150; 812-944-4097.

For Sale: Sencore SG165, excellent condition, \$750; Sencore PR57, \$300; Diehl Engineering Mark IV Supertech computer, \$300. Prices do not include shipping. Mark Vuozzo, 4592 Lockhaven, Irvine, CA 92715; 714-733-0372.

Wanted: For VCR repair - tape tension gauge and any tools needed for mechanical adjustments. Panasonic color picture tube No. A26JAS31X. Edward Herbert, 410 N. Third St., Minersville, PA 17954.

Wanted: Schematic and service information for RCA table radio, model 1058, chassis No. B274. Any charges will be paid by return mail. John G. Lefko, P.O. Box 782, Fairfield, CA 94538; 707-425-4578.

Wanted: Manual or schematic for Lambda LH130FM power supply. Will buy or copy. Also want plug-in PC boards for Sorensen QRC40-8A power supply, or does someone want the power supply and manual without the PC boards? Warren Kernaghan, 901 E. 108th St., Kansas City, MO 64131; 816-942-3615.

Needed: Video, sound, ACG/AFT module for Panasonic model CTA-314, chassis No. ETA-12, part No. TNP 65111. R.B. Wetherell, Wetherell Electronics, 14 West St., Wakefield, RI 02879.

Wanted: Information - How many connectors, cables or jumpers are used, or come with the B&K1076 TV analyst? I have one 6-foot (approximately) gray shielded cable with mic connector that goes to the front panel of this analyst; it also has two short red and black leads. What other wires come with the outfit? I will answer you and pay for your trouble. Jags Radio & TV, 14 Rudolph Road, Forestville, CT 06010.

Wanted: Panasonic main PC board assembly No. YFVPKB5470PA, new or rebuilt, for Monitor model WV5470. S.O. Sellers, TV Grouting, 1290 Oak Grove Road, Birmingham, AL 35209.

Wanted: Sams Photofacts CB Radio series Nos. 158, 170, 180, 187, 190, 207, 219, 221 and 251. **For Sale:** Sams Photofacts CB Radio series Nos. 35, 59, 72, 74 to 78 and 87. All are new, in original condition. \$6 each. S.H. Zagar, Swan Lake Enterprises, Box 384, Pengilly, MN 55775; 218-885-3710.

For Sale: Sams CB manuals from 1 to 280, best offer for entire lot; Hickok model 266 CB signal generator, \$125 firm, plus shipping; DSE teletex decoder to use on satellite or cable, used very little, \$200, plus shipping. Bill Coleman Jr., Coleman Electronics, 114 Circle Drive, Rocky Mount, NC 27804; 919-443-7870, after 5:00 p.m. EST.

Needed: Sams photofacts Nos. 1508 to 1682, 1858 to 1920, 1991 to 2004. Willy's Electronics, P.O. Box 56595, North Pole, AK 99705; 907-488-1307.

For Sale: Sencore model CG141 color generator, \$40; Sencore model TF166 transistor-FET tester, \$60. Both include manuals and leads. Heathkit model IP-17 power supply with manual, \$100. No reasonable offers refused. Dennis Dillon, 1616 S. 94th St., West Allis, WI 53214; 414-774-2255.

For Sale: Tektronix 535 oscilloscope with CA dual-trace plug-in, \$150; Tektronix 545A oscilloscope with CA plug-in and scope mobile, \$250. Anthony Luppino, 73 Selden Blvd., Centereach, NY 11720; 516-732-9440.

ES&T

ANSWERS to the QUIZ

Questions are on page 46

1. B. When there is a higher capacity in the tuned circuit, the lower capacity of the transistor and its associated circuitry has practically no influence on the frequency of the output signal.

2. B. You could answer this question even though you had never seen the symbol. You know it is not choice A or C because you know the symbols for those devices. Choice D is ridiculous.

Figure E shows the basic operational circuit for the adjustable shunt regulator, and the comparison of this device with a typical zener diode.

Texas Instruments makes these adjustable shunt regulators in (at least) two versions: TL430 and TL431.

3. A. The purpose of the coil is to make the antenna act as if it is physically longer, so it can resonate at a lower frequency. When the coil is removed (by a short circuit), the extra "length" is no longer provided, raising the frequency.

4. A. Of the definitions given, choice A is best. The circuit also is known as a buffer. It has unity voltage gain (voltage gain = 1). The output signal is the same shape as the input signal with no phase inversion. This op-amp connection is used to isolate two circuits from each other.

5. D. According to Texas Instru-

ments: *Proper digital design rules dictate that all unused inputs on TTL devices be tied either HIGH or LOW. This is especially important with FAST logic.*

Electrically open inputs can degrade ac noise immunity as well as the switching speed of the device. Small geometries make FAST more susceptible to damage by electrostatic discharge than other TTL families. Tying inputs to V_{cc} or GND, directly or through a resistor, protects the device from in-circuit electrostatic damage. Additionally, while most unconnected TTL inputs float HIGH, FAST devices with NPN inputs float LOW.

FAST devices do not require an input resistor to tie the input HIGH. Inputs can be connected directly to V_{cc} as well as ground.

6. B. The two filters are both shown in Figure E. Note the zero-gain (voltage-follower) amplifier configuration.

7. C. The term *slew rate* is used in several different ways. The one in this question refers to the slew rate of an operational amplifier.

8. B. None of the other terms have meaning related to inductance. Non-inductive windings are used in wire-wound resistors.

9. C. A potentiometer is an instrument that balances an unknown potential difference against an adjustable measurable difference.

A potentiometer is also a variable resistor used to divide a voltage, but that is not applicable to this question.

10. D. One plus one equals zero with a one carry.

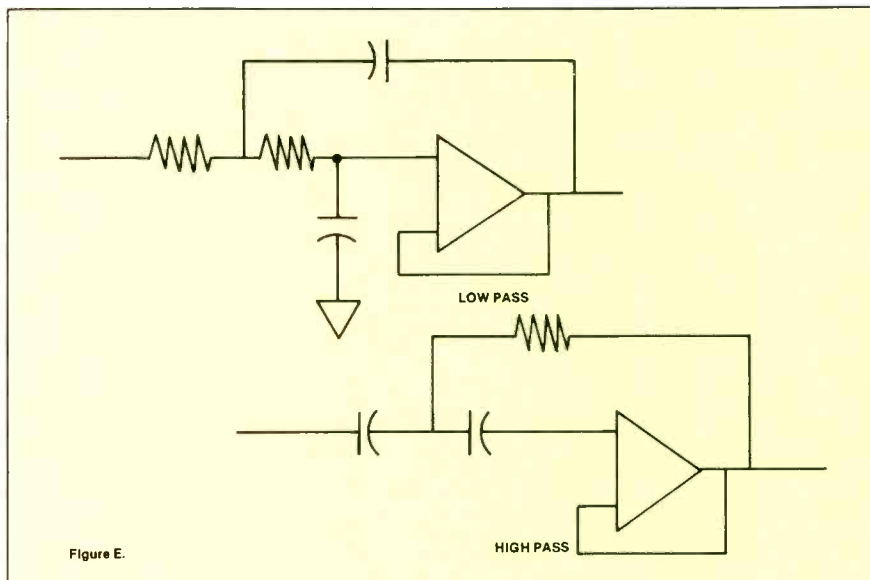

Figure E.

DISCOVER PROFITS WITH THE PRB BELT SYSTEM



PROJECTOR RECORDER BELT offers you the world's most complete inventory of replacement belts for all types of electronic equipment including . . .

- Video Recorders
- Turntables
- Cassette Recorders
- Projectors
- 8-Tracks
- 102 Video Belt Kits

PRB has the replacement belt you need in just the right shape, size and material. PLUS . . . our system helps you find that "perfect" replacement belt easily and fast. DISCOVER . . . The PRB Belt System for maximum convenience that assures profitable returns.

PRB . . . THE SOURCE FOR OVER 10,000 ELECTRONIC COMPONENTS

We stock virtually every electronic component. These are all high quality electronic components at everyday low prices backed by personalized service you can depend on. PRB will even pay the freight on your 1st pound of the UPS charge (ground only).

For details on our profitable belt system and a FREE copy of our 98 page 30th Anniversary Catalog, just write or call toll free . . .

NATIONAL 1-800-558-9572 IN WISCONSIN 1-800-242-9553

BUSINESS NUMBER
1-414-473-2151

In Canada call collect: 1-613-225-5003
TLX 4994411 PRB USA



PROJECTOR RECORDER BELT
200 Clay Street, Whitewater, WI 53190

Circle (28) on Reply Card

Products

Desoldering tips for SMDs

Weller CSF chip desoldering tips for surface-mounted devices desolder flat or quad packs without damaging circuit board leads, according to the manufacturer. The new desoldering accessory features a temperature control frame that spontaneously melts the solder of all connected leads. An adjustable suction cup, activated by a vacuum switch, lifts the component. The tips are available in seven threaded and seven tapered mounts.

Circle (75) on Reply Card

Smallest hand-held DMM

A.W. Sperry Instruments announces the digital multimeter, model DM-6593.

The AWS DM-6593 Electro-Probe is the smallest hand-held

DMM, says the Sperry company. Its features include autoranging, an interchangeable probe tip, electronic overload protection on all ranges, instant continuity buzzer, data hold button, and one-hand operation. It is designed especially for taking readings easily and accurately in hard-to-reach areas.

Circle (76) on Reply Card

An expanded line

Kikusui International, is featuring its DSS5040 oscilloscope, a 40MHz dual-channel, portable, digital storage/analog scope that delivers a 10MHz single-occurrence capture rate (25 megasample/second).

Another recently introduced addition to the digital storage scope line is the dual-channel, portable 20MHz DSS5020A, with easy-to-use function selection controls, similar to those on an analog scope.

KIK also has introduced the PAR 80A and PAR 160A regulated dc power supplies. Both products offer a range of voltage

and current outputs for maximum control and regulation of precision test. The Model PAR 80A has an 80W output in four voltage ranges, up to 80V. The 160W model PAR 160A has three ranges up to 80V.

Circle (77) on Reply Card

Hand-size digital testers

Models 3350 and 3360 autoranging digital multimeters, introduced by Triplet Corporation, a Penril Company, provide 19 ranges and seven functions for versatile equipment testing. (Model 3360 provides two additional dc/ac current ranges.)

Both units have 3.5 digit LCD displays, auto polarity with diode test and continuity check. Data hold and range hold are included on the model 3360.

Ranges include: 0-1,000Vdc in five ranges; 0-750Vac in four ranges; 0-10A ac/dc current in two ranges, model 3350 (model 3360 in four ranges); 0-20M Ω resistance in six ranges; 200 Ω continuity check; 2V diode test.

Circle (78) on Reply Card

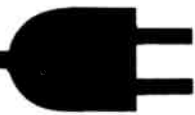

Plug in!

To the NESDA system.

YOUR BUSINESS is in the world's fastest changing industry. If you're not careful, you could find your business in the dark.

But, you don't have to stay there.

Through a system of local, state, and regional groups, the **National Electronics Sales & Service Dealers Assn. (NESDA)** keeps members up-to-date with the fast pace of advancing technology while offering:

- ◆ Managerial and technical training.
- ◆ Business contacts.
- ◆ Technical and management certification.
- ◆ Information on new products.
- ◆ Legislative activities that affect the industry.

Don't be left in the dark. Let the NESDA system work FOR YOU!

For more information and an application, write to:
NESDA, 2708 W. Berry St., Ft. Worth, TX 76109; Ph (817) 921-9061

Name _____

Bus. Name _____

Address _____

State _____ Zip _____ Phone _____

Member of State Local Assn. _____

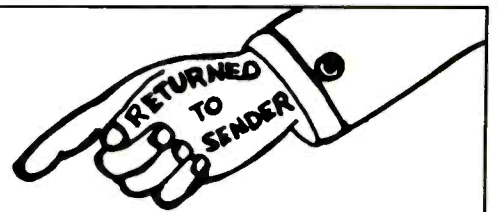

Moving?

Take us with you.

Just peel off the subscription mailing label and attach it to the address change card located at the front of this issue. Please allow 6-8 weeks to process your address change.

ELECTRONIC

Servicing & Technology

Hand-held DMM has D factor

American Reliance announces the Reliance AR-460D. According to the manufacturer, this is the industry's first hand-held DMM featuring LCR (inductance, capacitance and resistance) with D dissipation factor, an essential tool for use in engineering laboratories, incoming quality control, and by radio amateurs.

The device features seven ranges for capacitance testing; five ranges for inductance testing; six ranges for resistance testing. The dissipation factor range is from 0 to 19.99.

Circle (79) on Reply Card

Test probe replacements

E.F. Johnson Components Products has introduced test instrument probes designed to replace Triplet 310 probes.

Available in red or black, the test probes include unshrouded banana plug instrument-end terminations. They feature a solderless crimp connection to provide positive electrical contact and integral strain

relief that withstands 15 pounds or more of pull.

As original equipment replacements, these test probe sets meet all manufacturer specifications for safety, electrical and mechanical performance. They also follow the recommendations of proposed American National Standards Institute standards.

Circle (80) on Reply Card

Semiconductor general-purpose replacements

Howard W. Sams & Co., a division of Macmillan, has published the 6th edition of "Semiconductor General-Purpose Replacements," a 418-page volume.

This guide is designed to use various bits of available information to select the proper semiconductor replacement, such as a number stamped on the part or listed in a parts list.

U.S., European and Far Eastern type numbers and manufacturers' part numbers are included. The universal general-purpose replacement semiconductors of five sup-

pliers: NTE Electronics, Philips ECG, Radio Shack, RCA, and Zenith are given for the over 281,000 devices listed. This comprehensive listing is updated regularly by the Sams Photofact analysis department.

Circle (81) on Reply Card

Hand tools tested at 10,000V

CemenTex Products manufactures hand tools that, according to the manufacturer, are dielectrically safe. By applying layers of a proprietary plastic formulation onto a special base bonded to and covering tool-gripping surfaces (and sometimes the whole instrument), an extremely high level of user safety is achieved without adding excessive bulk to the tool. Each hand tool is dielectrically tested and visually inspected prior to shipment. The company has offered to coat individual workers' hand tools as a personal safety gesture. Insulation to 10,000Vac can be provided.

Circle (82) on Reply Card

ES&T



Quality Electronic Components
from
Nationally Recognized Manufacturers

- Computerized order processing and inventory control
- Multi-million dollar inventory
- Fast service
- Volume discounts
- Toll free WATS line

Your Source For: IC's, capacitors, optoelectronics, resistors, IDC connectors and cable assemblies, IC sockets, transistors, hexfets, diodes, crystals, coils, chokes, transformers, power supplies, relays, switches, potentiometers, fuses, breadboarding, testing equipment, tools, hardware, batteries, solder and accessories and much, much more!!! Call or write for your first 84 page catalog.

DIGI-KEY CORPORATION

701 Brooks Ave. South, P.O. Box 677
Thief River Falls, MN 56701

1-800-344-4539

Circle (27) on Reply Card

MODULAR PROBES FOR SALE

For All Oscilloscopes
To 300MHz
X1 to X100
Attenuation

Pictured
Accessories
Included



INSTANT REPAIR

Probe tip, Head, BNC and Cable all screw into place easily and quickly.

TEST PROBES, INC. TPI

Your Probe Specialists

Coline U.S. Sales & Stocking Source P.O. Box 2113, La Jolla, CA 92038 (619) 459-4197

COMPARE PRICE — COMPARE PERFORMANCE

Model	Attenuation	Bandwidth	Price
M12SW	X1-X10 Switchable	X1-10MHz X10-250MHz	\$72.00
M12X10	X10	250MHz	62.00
M12X10AP	X10 with Readout	250MHz	68.00
M15X100	X100	250MHz	79.00
M15X10HF	X10	300MHz	79.00
M12X1	X1	30MHz	38.00

Circle (29) on Reply Card

The past several years have been fertile ones for audio. Coming out of the malaise of the late '70s, design engineers began to fundamentally rethink audio reproduction. New tools derived from video technology produce previously impossible levels of performance that affect the most critical component of the reproduction chain, the signal source. From the videodisc, we get compact disc (CD), from the VCR, VCR hi-fi, and from nascent 8mm, we have PCM (pulse-code modulated) audio.

Actually, PCM audio has been around for nearly as long as VCRs. Add-on units were available that changed incoming audio into a digital format compatible with the recording characteristics of NTSC video. The sampling rate and performance of these units is virtually identical to that of the CD. But the new 8mm video format has made high quality audio available from a cassette not much larger than a standard Philips musicassette. Some units even can record up to 24 hours of audio on a single 8mm tape. Performance is similar to VCR hi-fi, an analog format. The constraints imposed on the 31kHz sampling rate limit high frequency response to 15kHz. The 8-bit word size yields a theoretical S/N (signal to noise) ratio of 48dB, but a little electronic massage boosts this to around 80dB. As a comparison, the CD has an inherent 96dB S/N ratio, and a 41kHz sample rate, resulting in a flat response to 20kHz.

Analog into digital

Analog signals vary smoothly over a given amplitude range. Within this range there are an infinite number of possible values. But digital signals only have two, high or low, *on* or *off*. A similar distinction exists between a potentiometer and a switch.

In order to change analog voltages into a train of digital pulses, engineers developed a technique called sampling. By taking a discrete measurement of the analog voltage at an instant of time, and converting this reading into a digital code, the voltage level for that moment is converted. If we sample quickly enough, we can do a good job of accurately converting the analog signal into a series of pulses without the loss of much information. Theoretically, and empirically, it has been confirmed that the required sampling rate is at least twice the highest frequency to be digitized. For 8mm PCM, this comes out to 31.5kHz, which, not coincidentally, is twice the NTSC horizontal scan rate. This gives us a maximum high end of 15kHz, about the same as a good audiocassette deck. Compare this to CD and 1/2-inch PCM, with a sampling rate of 44.1kHz and a top end of 20kHz.

The Achilles heel of digital audio is a phenomenon called *aliasing*. By examining the products of the sampling process in the *frequency domain*, that is, with a spectrum analyzer, we can see that, in addition to the desired information, the sampling frequency and two sidebands, whose maximum bandwidth is equal to the highest sampled frequency, are present. As you can see from the diagram, if the sampled frequency is greater than one-half of the sample rate, the lower sideband and the top end of the audio band will overlap, producing some of the most annoying distortion you're likely to experience. For this reason an anti-aliasing filter is used to eliminate any signals greater than one-half the sampling frequency. Designing a sharp-cut filter that doesn't perturb the desired audio band is the stuff dreams are made of. Frequency response irregularities noted among 8mm PCM machines are often due to this filter. Seldom does the top end look as smooth as that of a VCR hi-fi or even a top-notch audiocassette machine.

First the information is filtered, sampled, and converted to a string of discrete pulses with varying amplitude, a technique termed pulse amplitude modulation (PAM). Next, an analog-to-digital (A/D) converter changes these pulses into digital *words*, in this case 8 bits long. The raw dynamic range (S/N ratio), theoretically, is 6 x number of bits, or 48dB, which is less than breathtaking. (Compare this to a CD, which uses 16-bit words, yielding a 96dB S/N ratio.) A trick called "10-to-8 bit non-linear quantization" extends the dynamic range at low signal amplitudes, where it is most noticeable, at the expense of S/N ratio at

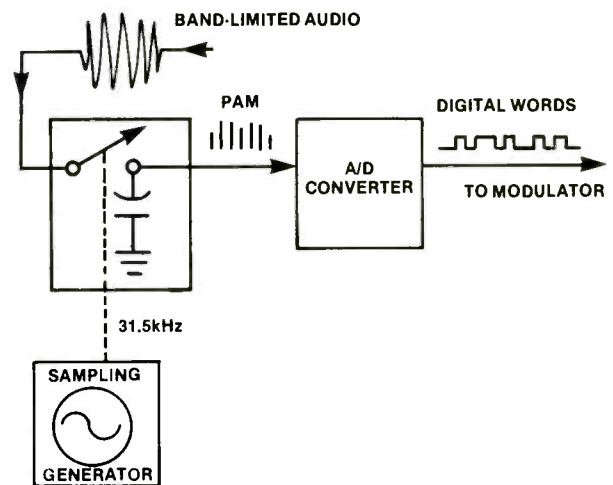

Figure 1. SAMPLING AND ANALOG-TO-DIGITAL CONVERSION

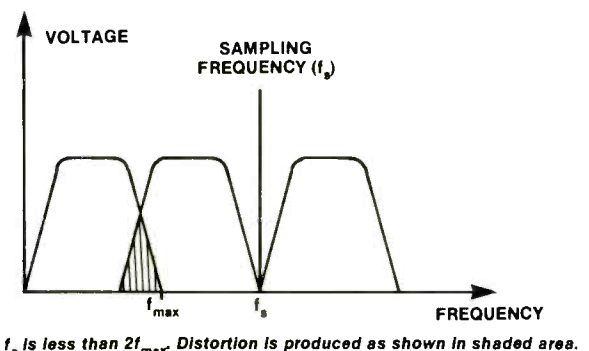
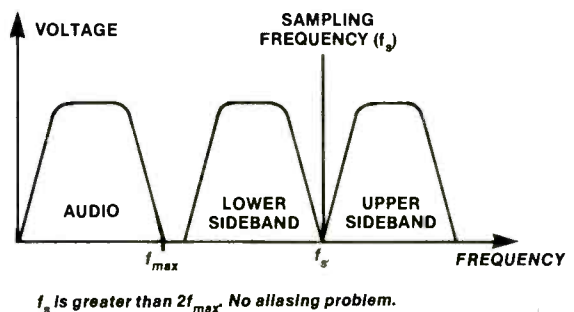

Figure 2. ALIAS EFFECT

the upper end. Fortunately, at higher volume, the musical material masks noise, so the decrease is not noticeable. Additionally, the analog signal is compressed before sampling, and expanded after D/A conversion, roughly doubling the overall dynamic range of the system. The result of all this number crunching and signal massaging is a respectable frequency response, good distortion characteristics, excellent dynamic range, and 24 hours of audio on a single cassette.

Recording the digital data

An 8mm uses a rotary head, helical-scan system, similar to Beta or VHS, to record both audio and video information. The 8mm format specifies one channel of AFM, recorded in the video track, as with Beta hi-fi. A special, stereo PCM section also is specified. Normally it is recorded during the first 31° of head rotation, then video in the remaining 180°. But, in the multi-PCM (audio-only) mode, the entire width of the tape is devoted to PCM. The extra space is derived by dividing up the video section of the tape, producing a total of six separate stereo audio tracks. Some very sophisticated (read that *complicated*) switching is done to keep everything straight.

The signal is laid down on the tape by recording a carrier, which is shifted between about 2.9MHz and 5.8MHz, depending on whether a digital high or low is present. This process is called *bi-phase* modulation. A sync signal marks

the beginning of a block of data words. Being at a lower frequency than the other data, it is easily distinguishable.

The extremely high information density requires great attention to timing. A master clock, phase locked to a servo reference pulse, controls nearly all the switching necessary to separate the correct PCM track from the six that coexist on the 1/3-inchwide tape. After working on an 8mm timing problem, troubleshooting CD servos seems like a vacation. On the plus side, ATF (automatic track finding) eliminates the need for a control head, and greatly improves tracking. In general, 8mm machines seem a good deal more reliable than their internal complexity would lead you to believe.

The troubling aspect of all these new audio formats is that customers are getting confused, shades of the 4-channel fiasco of the mid-'70s. So far, the '80s have produced CD, VCR hi-fi, 8mm PCM, and soon, recording CDs and direct digital audiocassettes. Add these to previous analog audiocassettes and phonograph records. What you've got is more formats than the market can support. A shakeout is inevitable. The only question is the identity of the survivors. The wild card in all this is video. Many of the audio systems are integrated with video, or are video-upgradable (such as still pictures on CD). Whoever finally wins, one thing is certain, audio performance will have been significantly upgraded, both in terms of signal quality and information density (playing time).

ES&T

Technicians,
Get Serious
About Your
Profession



Being a certified electronics technician lets people know that you are a professional in your field. It tells them that you are serious about your work and can perform up to CET standards.

Now you can order the "Study Guide for the Associate-Level CET Test" from the International Society of Certified Electronics Technicians. It includes material covering the most often missed questions on the Associate CET Exam 8 1/2" x 11", paperback, 60 pages.

For More Information Contact:
IS CET 2708 W. Berry, Ft. Worth, TX
76109. (817) 921-9101

NAME _____
ADDRESS _____
CITY _____ STATE _____
ZIP _____

_____ copies @ \$5 (+ \$1 postage.)

_____ send material about IS CET
and becoming certified.

Quick charge cordless
soldering iron. Up to 125
electronics joints per
charge. Total recharge
in less than 4 hours.
Isolated tip design. One
of more than 2 dozen
ISO-TIP and STERLING
irons available. Write for free
catalog and name of
nearest distributor.

A Hot Tip on
Cordless
Soldering

ISO-TIP®
STERLING®

No. 7700
QUICK CHARGE
Cordless
Soldering Iron

WAHL CLIPPER CORPORATION
Sterling, Illinois 61081 • (815) 625-6525



Circle (30) on Reply Card

Literature

Now available is the 8-page Selection Guide #206 describing **Connector Corporation's** expanding line of CRT sockets for Cathode Ray Tubes. The catalog details CRT socket families that are available for most JEDEC base configurations and those not so designated. All sockets are made to order utilizing a wide range of materials and finishes to suit the exact requirements of the application.

Circle (125) on Reply Card

A booklet from **Microwave Filter Company**, "TVRO Service Dealer's Master Receiver List and Filter Connection Guide," describes filtering terrestrial interference (TI) in more than 500 different receivers.

The booklet discusses how to identify whether a receiver is stan-

dard or block conversion, its IF frequency, connector type and whether it's synthesized or automatic frequency control driven. Based on characteristics identified, the best filter to solve the interference problem is recommended. Two other filters are also listed: a second best and one for weak signal. Diagrams show where the filters should be installed in the system. Descriptions of the filters also are included.

The data were compiled by MFC staff who have helped dealers with 10,000-plus cases of TI.

Circle (126) on Reply Card

The Eraser Company announces the availability of a new 12-page Short Form Catalog, presenting most of its electrical and electronic production equipment, in a shortened, comprehensive brochure. Included is a selection of equipment used to solve many production problems in industry. Applications such as wire cutting and stripping, printed circuit board assembly, wire and cable dereeling, and cleaning and burnishing operations are featured.

Circle (127) on Reply Card

Jensen Tools offers a full color, 160-page catalog containing more than 1,000 items. Two new sections feature supplies and equipment in support of fiber-optics and wire/cable systems. The line of circuit board equipment has been expanded. Other major categories cover lighting and optical aids, metric, power and metalworking tools, work-holding devices, drafting supplies and more than 50 dedicated tool kits.

Circle (128) on Reply Card

Comprehensive home study courses in video technology and TV/radio servicing with digital electronics are featured in a new catalog issued by **National Technical Schools/Independent Training Group** (division of **United Education & Software**). Also included are independent study programs in electronics, industrial technology and microprocessors, robotics technology, personal computer technology and servicing, transportation technology and climate control technology.

Circle (129) on Reply Card

ES&T

Photofact

These Photofact folders for TV receivers have been released by Howard W. Sams since ES&T's last report.

GENERAL ELECTRIC

Chassis 13BC-A.....2452-1

MAGNAVOX

Chassis 15C301-00AA.....2446-1

MAGNAVOX

Chassis 13C3A1-00AA.....2448-1

MAGNAVOX

Chassis 26C501, 26C502.....2450-1

PHILCO

Chassis 13C304, 13C311, 13C314.....2446-2

SANYO

Chassis A2S-62100.....2447-1

SEARS

564.48600550, 564.48601550.....2447-2

SEARS

562.42470550, 562.42470551.....2449-1

SHARP

FF19664, 19KP55.....2449-2

SHARP

25J750.....2450-2

TOSHIBA

Chassis TAC8531, TAC8536.....2451-1

TOSHIBA

Chassis TAC8530, TAC8535.....2452-2

WARDS

GNB-12806A, GNB-12884D, GNB-17016C.....2448-2

ZENITH

SA2541X/X8/X77/49P/49P8/49P77/71CH/
71CH8/71CH77/77P/77P8/77P77/79X/79X8/
79X77/95P/95P5/95S/95S5.....2451-2

ATTENTION TECHNICIANS

- ★ JOB OPENINGS
- ★ MONTHLY TECHNICAL TRAINING PROGRAM
- ★ BUSINESS MANAGEMENT TRAINING
- ★ LOW COST INSURANCE
- ★ CERTIFICATION
- ★ TECHNICAL SEMINARS

All of this in a nonprofit international association for technicians

FIND OUT MORE:



604 N. Jackson St.
Greencastle, IN 46135

Technicians

**Our world of Home Electronics...
your new home for growth.**

If you're looking for a growth opportunity with a company that has expanded from 12 employees to over 400 in just five years, NEC Home Electronics (U.S.A.) Inc. may be just for you.

Due to our tremendous expansion, we are seeking Technicians to work in various locations throughout the nation. If you have a 2 year technical degree or equivalent experience and are well versed in any of the following areas, we'd like to talk with you.

- Audio Products
- Projection TVs
- VCRs
- Camcorders
- PC Products & Peripherals

We offer competitive salaries, an excellent benefits package including educational assistance and the outstanding opportunity to advance rapidly.

For immediate consideration, please call 1-800-323-1728, weekdays during business hours, or send resume, including salary history, to: Personnel Dept. EST, NEC Home Electronics (U.S.A.) Inc., 1255 Michael Drive, Wood Dale, IL 60191-1094. We are an Equal Opportunity Employer.

**where our performance
matches our promise**

NEC

NEC Home Electronics (U.S.A.) Inc.

Classified

Advertising rates in the Classified Section are 85 cents per word, each insertion, and must be accompanied by payment to insure publications.

Each initial or abbreviation counts a full word.

Minimum classified charge is \$20.00.

For ads on which replies are sent to us for forwarding (blind ads), there is an additional charge of \$30.00 per insertion to cover department number, processing of replies, and mailing costs.

Classified columns are not open to advertising of any products regularly produced by manufacturers unless used and no longer owned by the manufacturer or distributor.

FOR SALE

AUTOMOBILE RADIO and tape replacement parts. Delco, Chrysler, Philco-Ford, Motorola, Panasonic and many others. Large inventory. Laran Electronics, Inc., 3768 Boston Road, Bronx, NY 10469. (212) 881-9600. National (800) 223-8314, NY State (800) 446-4430. 1-85-tfn

BOOTLEGGERS BIBLE for CB Modification \$12.95, CB Radio Repair \$10.95. Linear Amplifier Planbook \$14.95, kits, etc. Catalog \$1.00 refundable — APS, POB 263 Newport, R.I. 02840 401-846-5627. 12-84-tfn

CABLE TV CONVERTERS & EQUIPMENT. Plans and parts. Build or buy. Send S.A.S.E. C&D Electronics, P.O. Box 1402, Dept. ES&T, Hope, Arkansas 71801. 1-86-tfn

SONY-TRINITRON REBUILTS are now available. Call for price & delivery, 1-716-621-5250. 7-86-tfn

INDIVIDUAL PHOTOFAC TOLDERS (not sets) #1 to #1400, \$3.00 first-class postpaid. Loeb, 414 Chestnut Lane, East Meadow, NY 11554. 8-86-6t

3000 COLOR TV REPAIR TIPS, 31 Brands 116 Page Manual. Send \$21.00 to A. Fernandez, Box 546110, Surfside, Florida 33154. 10-86-3t

FOR SALE: Descramble the latest video cassette copy protection scheme. Our simple LINE ZAPPER circuit takes the jitter out of your picture. Complete plans and theory only \$9.95 plus \$1.50 postage and handling. Printed circuit board or complete kit also available. Elephant Electronics Inc., Box 41865-E, Phoenix, AZ 85080 (602) 581-1973. 10-86-tfn

FORSALE: Jerrold gated pulse theory. Twelve information packed pages covering DI & DIC converter operation. Includes introduction to trimode system. \$6.95 plus \$1.50 postage and handling. Elephant Electronics Inc., Box 41865-E, Phoenix, AZ 85080 (602) 581-1973. 10-86-tfn

SERVICE MANUALS. Large Shop has 18 yr. collection of duplicates. All original manufacturer. All new. Audio \$2.00, video \$5.00. Send SASE for list. Tape Recorder Clinic; 4850 E. Speedway; Tucson, Arizona 85712. 11-86-tfn

SAM'S PHOTOFAC TS 1 thru 2437 and MF 1 thru 170 in file cabinets. Sell all for \$2000.00. Retiring. 704-873-9807, 704-872-2395. 12-86-1t

CB TUNE-UP MANUAL VOLUME II. Specific adjustments and modifications for peaking all popular CB's. Covers over 1300 radios — 19.95, Visa, Mastercard to: Thomas Publishing, 127E Westwood, Paris, IL 61944. 12-86-1t

TV TROUBLESHOOTING: Over 120 schematic ILLUSTRATED problems-solutions of difficult repairs. 25 pages of valuable tech data. \$12.00. Jones, Box 702, Niceville, Fla. 32578. 12-85-3t

VCR REPAIR SOLUTIONS for VHS models. Over 150 symptoms and cures. The hard ones. Send \$11.95 to Eagle Electronics, 2534 Miracle Lane, Mishawaka, IN 46545. 12-86-6t

AUDIO EQUIPMENT for sale. New and used. Speakers, amplifiers, cable. Call or write for list. North Star Technical, P.O. Box 1992, Hollywood, FL 33020. (305) 921-5868. 12-86-1t

FOR SALE: Radar Range Scope, early 1940's. DuPont, weighs about 90 lbs., several G's shock resistant. ALSO Webcor High Fidelity, reel-to-reel, tube type Tape Recorder Mod. TP2718-1, weighs about 40 lbs. Make offer on each. SHANNON O. SELLERS, 7308 Franklin Dr., Bessemer, AL 35023. 12-86-1t

HELP WANTED

CAMERA-VIDEO Technicians needed. Top pay and benefits for well trained and experienced technicians who are expert with consumer and/or industrial cameras and VCR's. Training by manufacturers such as Sony, Hitachi, Panasonic, etc., are necessary for job experience. Come to sunny Florida and enjoy your work & leisure time. Write or call ATLANTIC ELECTRONICS INC., 1881 NE 26 St., Ft. Lauderdale, FL 33305. (305) 564-8274 10 AM to 6:30 PM. Ask for Dave or Joe. 8-85-tfn

ELECTRONIC TECHNICIAN/SERVICE SHOP MANAGER needed for small busy repair shop. Send resume to Whittington's Electronics, 501 Broadway, Truth or Consequences, New Mexico 87901. 10-86-2t

VIDEO/AUDIO technician needed. Top pay and benefits for well trained and experienced technicians who are expert with consumer TV and audio equipment. Training by manufacturers such as: Sony, Hitachi, RCA, Panasonic, etc. are necessary for job experience. Write or call: Atlantic Electronics, Inc., 1881 NE 26th St., Ft. Lauderdale, FL 33305, 305-564-8274 (10 AM 6:30 PM). Ask for Dave or Joe. 06-86-tfn

WANTED — Part-time television-tech. benchman. Experienced only — seasonal only. Paul's T.V., 6564 S. Federal Hwy., Stuart, FL 33497. 12-86-1t

BUSINESS OPPORTUNITIES

T.V. SALES & SERVICE. Well established business located northern Virginia. Owner retiring and will help with financing. Call 703-972-7027 after 7:00 p.m. EST. 6/85-tfn

Bus. Opportunity (Cont.)

3 HOURS FROM SAN FRANCISCO, Electronic repair shop in Pine Forested foothills. Vision problem forces sale. 7 rm residence, lg beautiful gdn all shop equip included, \$155k min 50% dwn req (916)872-1962. 10-86-tfn

RADIO-TV REPAIR SHOP! USA Virgin Islands! Established 15 years—reasonably priced—809-773-7867. 10-86-4t

FLORIDA: T.V. sales and service. Established 29 years. Oceanfront community. Big name, long term clients. Health problems forces sale. Business \$169,000. Commercial property with 2 rental apartments, just yards from the beach only \$198,000. Will sell as a package deal with low downpayment and excellent owner financing. If you are tired of miserable northern winters, have a little money saved up and know how to service and sell T.V.'s, then quit procrastinating—make Florida your new home. Call: WARREN SIMONDS, C.C.L., MERRILL LYNCH REALTY, Sarasota, Florida, (813) 366-8080 or (813) 383-1657. 12-86-1t

TV-VCR-STEREO Service Business For Sale. Est. 26 years—Retiring. Have Warranty service for 33 major companies. Long Island, N.Y. 516-475-2203. 12-86-1t

EXCELLENT ZENITH RCA SALES SERVICE, North Idaho. Commercial building and adjoint lot. 90,000.00. Owner retiring, will help financing. (208) 773-9522 or 773-3255 evenings. 12-86-2t

WANTED TO BUY

WANT TO BUY: Sencore VA62, with VC63, NT64, Matney TV, 151 Chase, Florence, S.C. 29503, 803-662-5419. 12-86-1t

WANTED TO BUY: well established profitable consumer electronic sales/service business in Florida. Write Electronic Services, 16820 SW 108 Ave., Miami 33157. 12-86-1t

SERVICES

TELEVISION TUNER REBUILDING, all makes & models. 24-hour turnaround, one year limited warranty. Competitive pricing. Contact: Electrodyn, 917 South Rogers St., Bloomington, In. 47401. Telephone: 812-334-1023. 12-86-2t

TVRO EQUIPMENT REPAIR, satellite receivers, antenna actuators and down converters. 72-hour turnaround, 90-day limited warranty. Contact: Electrodyn, 917 South Rogers St., Bloomington, In. 47401. Telephone: 812-334-1023. 12-86-2t

COLLEGE DEGREE

in **ELECTRONICS** by Home Study

• Fully Accredited by Accrediting Commission of NHSC •

No commuting to class. Study at your own pace, while continuing your present job. The Grantham home-study program leads first to the A.S.E.T. and then to the B.S.E.T. degree. Our free bulletin gives full details. Write for *Bulletin ET-86*.

Grantham College of Engineering
10570 Humbolt Street
Los Alamitos, California 90720

NATIONAL REBUILT HEADQ. FOR—

**SONY REBUILT
PICTURE TUBES**

2 YR. WARR. — FREE U.P.S.-DEL.

716-621-5250

Circle (31) on Reply Card

**Use ES&T
classified ads**

Advertisers' Index

	Page Number	Reader Service Number	Advertiser Hotline
A.F. Publishing Co.	66	34	
Beckman Industrial Corp.	54	10	714/671-4800
C & S Sales	52	23	800/292-7711
Dandy Mfg. Co.	66	33	800/331-9658
Diehl Enterprises	17, 19, 55	11, 12, 25	806/359-0329
Digikey	61	26	800/344-4539
Digitron Electronic	57	26	800/526-4928
ETA	65		
Fluke, John Mfg. Co., Inc.	3	4	800/227-3800
Fordham Radio Supply Co.	25	14	800/645-9518
Grantham College of Engineering	66		
Hitachi Sales Corp. of America	51	22	516/921-7200
ISCET	63		
Leader Instrument Corp.	IFC	1, 2	514/337-9500
MCM Electronics	27	15	800/543-4330
Mitsubishi	11	9	800/421-1099
NESDA	57, 60		
Optima Electronics	21	13	305/652-3971
Precision Picture Tubes	66	31	716/621-5250
Projector Recorder Belt Corp.	59	28	800/558-9572
PTS Corp.	29	16	812/824-9331
RCA Distributor and Special Products	7	7	800/227-3800
Sams, Howard W. & Co., Inc.	5	5	800/428-SAMS
Sencore, Inc.	41, 43	17, 18	800/843-3338
Sencore, Inc.	45, 47	19, 20	800/843-3338
Sperry AW Instruments Inc.	53	24	800/645-5398
Sperry Tech, Inc.	66	32	800/228-4338
Tech Spray	9	8	800/858-4043
Tektronix, Inc.	IBC	3	800/433-2323
Tentel	39	35	800/538-6894
Test Probes, Inc.	61	29	619/459-4197
U.S. Instrument Rentals	49	21	800/824-2873
Wahl Clipper Corp.	63	30	815/625-6525
Zenith	BC		

Tech's Guide To Pricing
NEW

updated new 5th edition...a framework for setting rates that apply to Hi-Tech products...a formula that guarantees SUCCESS!

Call Toll Free for details
1-800-228-4338 8/5 CST

Circle (32) on Reply Card



NEW IDEAS FOR THE HOBBYIST IN A UNIQUE MAGAZINE/NEWSLETTER FORMAT. FREE DETAILS.

AF PUBLISHING
Dept. A12, P.O. Box 524
So. Hadley, MA 01075

Circle (34) on Reply Card

A MUST FOR THE TV TECHNICIAN

UNIVERSAL CRT ADAPTER: Don't buy another socket for your CRT Tester! Join 10,000 satisfied buyers & WIN the Socket War! GUARANTEED to fit your tester. Test/clean/restore ALL Color, B/W, Projection. \$59.99ppd w/Setup book, Visa, MC, COD.



1-800-331-9658

DANDY MFG. CO.

2323 Gibson, Muskogee, Oklahoma 74403

Circle (33) on Reply Card

ELECTRONIC SERVICING & TECHNOLOGY (Volume 6 No. 12 (USPS 462-050) is published monthly by Intertec Publishing Corp., 9221 Quivira Road, P.O. Box 12901, Overland Park, KS 66212. Second Class Postage paid at Shawnee Mission, KS, and additional mailing offices. POSTMASTER: Send address changes to ELECTRONIC SERVICING & TECHNOLOGY, P.O. Box 12952, Overland Park, KS 66212-9981.

ELECTRONIC

Service & Technology

KANSAS CITY, MISSOURI
Greg Garrison, Sales Manager
P.O. Box 12901
Overland Park, KS 66212
Phone: 1-913-888-4664

NORWOOD, AUSTRALIA
Hastwell, Williamson, Rouse PTY. LTD.
P.O. Box 419
Phone: 332-3322
Telex AA 87113

LONDON, ENGLAND
Nicholas McGeachin
Suite 460, Southbank House
Black Prince Road, London SE1 7SJ
Telex: 295555 LSPG
Telephones: Central Line 01 582-7522
Direct Line 01 587-1578

TOKYO, JAPAN
EMS, Inc.
Sagami Bldg., 4-2-21,
Shinjuku, Shinjuku-ku,
Tokyo 160, Japan
(03) 350-5666
Telex: 2322520 EMSINCJ
Cable: EMSINCPERIOD

Use the card below to RENEW your subscription or to START a new subscription.

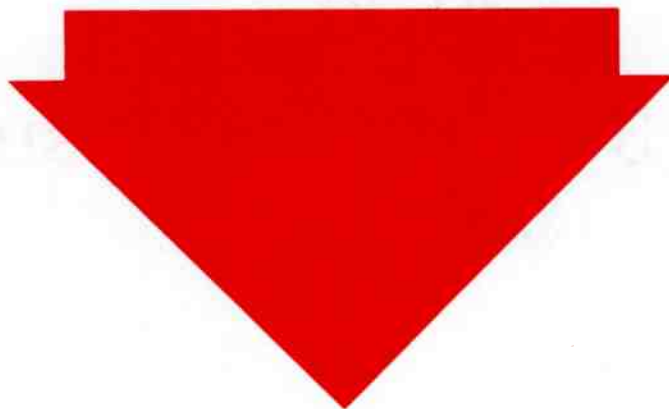

Please print
 Name _____ Title _____
 Company Name _____
 Address _____
 City _____ State _____ Zip _____
 BUSINESS TELEPHONE: AREA CODE () NUMBER _____
 Signature _____ Date _____

SAVE TIME
 Use paper-cut
 address label
 from Reader
 Service

Please check one box under each arrow below.

- Type of Business
- 21 Consumer Electronics Equipment Independent or Franchised Service Business
 - 22 Retailer With Consumer Electronics Equipment Service Department
 - 23 Electronics Equipment Field Service Organization
 - 24 Service, Installation or Operation of Electronics Equipment In Industrial Or Commercial Facility
 - 33 Engineering Of Electronics Equipment In Industrial Or Commercial Facility
 - 35 Wholesaler, Jobber, Distributor
 - 37 Electronics Equipment Or Components Manufacturer
 - 38 Government and Military: Federal, State, Municipal
 - 09 Education
 - (a) College, Library, School, Including Instructors
 - (b) Student
 - 30 Other
- Position
- EE **Company Management**
Such as General Manager, Owner, Partner, President, Vice President, Director And Other Corporate Personnel
 - FF **Operations Management**
Such as Service Manager, Operations Manager, Production Manager, Customer Service Manager, Marketing/Sales Manager, Purchasing Manager, Credit/Accounts Manager and Other Operations/Administrative Personnel
 - GG **Engineering/Technical & Other Personnel**
Such as Engineer, Technician, Field Service Engineer, Specialist, Engineering Associate and Other Engineering And Technical Support Personnel
 - KK Other

► Check the number of Service Technicians employed at your facility.

- A 1 - 5
- B 6 - 20
- C 11 - 25
- D 26 - 50
- E Over 50
- F Not applicable

► Check the statement that best describes your role in the purchase of major electronics servicing equipment and servicing components, accessories and services.

- 1 Make final decision to buy a specific make or model.
- 2 Recommend make or model to be purchased.
- 3 Have no part in specifying or buying.

SUBSCRIBE NOW!

- 1 Year—12 issues **ONLY \$18.00**
 - 2 Years—24 issues **ONLY \$30.00**
 - 3 Years—36 issues **ONLY \$38.00**
- Handwritten: "You Biggest Savings!" with an arrow pointing to the 3-year option.*
- Handwritten: "Please check preferred order (Allow 6-8 weeks for delivery of first issue)"*

Note: Outside U.S.A. rates are: 1 Year \$22 2 Years \$34 3 Years \$44

- Payment enclosed
- Charge to my VISA/MASTERCARD
- Bill me later

CHARGE TO MY: (Please check one)

MASTERCARD VISA

ACCOUNT NUMBER _____
 INTERBANK NUMBER _____
 MASTERCARD ONLY (4 digits above your name) _____
 CARD EXPIRES _____ MO. YR.

Signature required _____ Date _____

Subscriptions:

1 Year – 12 Issues
\$18.00

2 Years – 24 Issues
\$30.00

3 Years – 36 Issues
\$38.00

NO STAMP – NO ENVELOPE NECESSARY
FOLD – TAPE – MAIL

No Postage
Necessary
if Mailed
in the
United States

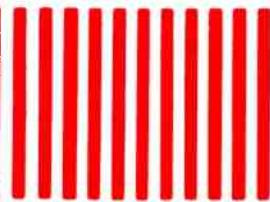

BUSINESS REPLY MAIL

First Class Permit No. 1810 Overland Park, KS

Postage Will Be Paid By Addressee

ELECTRONIC

Service & Technology

SUBSCRIPTION SERVICE

P.O. Box 12901
Overland Park, KS 66212-9981



NOW GET SCOPE, COUNTER AND DMM INPUT ALL AT ONCE THROUGH ONE PROBE!

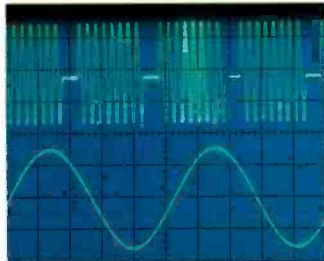

Gated frequency measurement. B sweep triggering during the intensified portion of the A sweep. Intensified portion frequency is measured with the counter/timer/DMM.

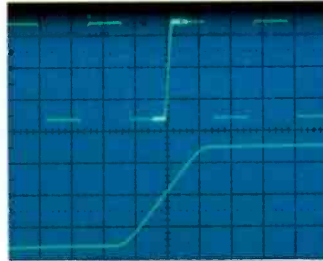

Delay time measurement. Delay time from the start of A sweep to the start of the B sweep is measured with crystal accuracy.

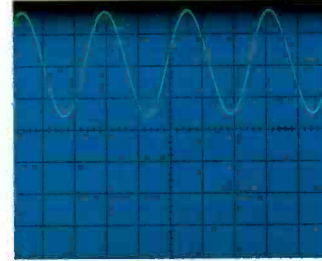

Channel 1 dc volts measurement. The average dc component of a waveform is measured directly through channel 1 with direct digital fluorescent readout.

The Tek 2236 combines 100 MHz, dual timebase scope capability with counter/timer/DMM functions integrated into its vertical, horizontal and trigger systems. For the same effort it takes to display a waveform you can obtain digital readout of frequency, period, width, totalized events, delay time and Δ -time to accuracies of 0.001%.

The same probe is used to provide input for the CRT display and the digital measurement system, resulting in easy set-up, greater measurement confidence and reduced circuit loading. Probe tip volts can also be measured through the Ch 1 input.

Precision measurements at the touch of a button.

Auto-ranging frequency, period, width and gated measurements are push-button-simple. And the 2236 offers an independent floating 5000 count, auto-ranging multimeter with side inputs for DC voltage mea-



Bandwidth	100 MHz
No of Channels	2 + Trig. View
Max. Sweep Speed	5 ns/div
Digital Readout Features	Direct Ch 1 Voltage Meas. 0.5% DC; 2.0% AC RMS Resistance: .01 Ω to 200 Meg Ω Continuity/Temp: Audible/C $^{\circ}$ or F $^{\circ}$ Totalizing Counter: —1 counts to 8,000,000 Direct Freq. Meas: 100 MHz to 0.001% acc. Period, Width Meas: 10 ns with 10 ps max. resolution
Timing Meas. Accuracy	.001% (delay and Δ -time with readout)
Trigger Modes	P-P Auto, Norm, TV Field, TV Line, Single Sweep
Weight	7.3 kg (16.2 lb)
Price	\$2650
Warranty	3-year including CRT (plus optional service plans to 5 years)

surements to 0.1%.

A built-in, auto-ranging ohmmeter provides resistance measurements from 0.01 Ω to 2G Ω —as well as audible continuity. Automatic diode/junction detection and operator prompts serve to simplify set-up and enhance confidence in your measurements.

The 2236: scope, counter, timer, DMM plus a 3-year warranty — all for just \$2,650.

Contact your nearest distributor or call Tek toll-free. Technical personnel on our direct-line will answer your questions and expedite delivery. Orders include probes, 30-day free trial and service worldwide.

Call Tek direct:

1-800-433-2323 for video tape or literature,

1-800-426-2200 for application assistance or ordering information.

In Oregon, call collect: **1-627-2200**

Tektronix
COMMITTED TO EXCELLENCE

Start the New Year right by selling Zenith Video/Audio Accessories to the same people whose electronic products you now service.

Like all Zenith products, Zenith Audio/Video Accessories are made to the same uncompromising quality and performance standards that have earned Zenith a reputation unsurpassed in consumer electronics.

And it goes without saying that the better known and the more respected a product's name the easier, faster, and the more profitably you can sell it across the counter ...or while you're out of the shop on a service call.

To learn how it's done, how other service techs just like you are cashing in on the selling power of the Zenith name, call your Zenith distributor's Accessory Sales Manager now.

Everything you need is there at your Zenith distributor's place - the help and encouragement of an

experienced Zenith Accessory Sales Manager...the selling power of the Zenith name on video and audio accessories...and the overall support of your Zenith distributor's dedicated personnel.

With easy access to this wealth of know-how, you should have no trouble turning some 6, 7 or 8 feet of your floor space into a very respectable profit center. With Zenith Electronic Accessories, of course.

Call your Zenith distributor's Accessory Sales Manager now or write direct for the name of the Zenith distributor serving your area.

Call or write now, today!



The quality goes in before the name goes on.®

Zenith Service, Parts & Accessories • Department 30 • 11000 Seymour Avenue, Franklin Park, Illinois 60131 • A Division of Zenith Electronics Corporation

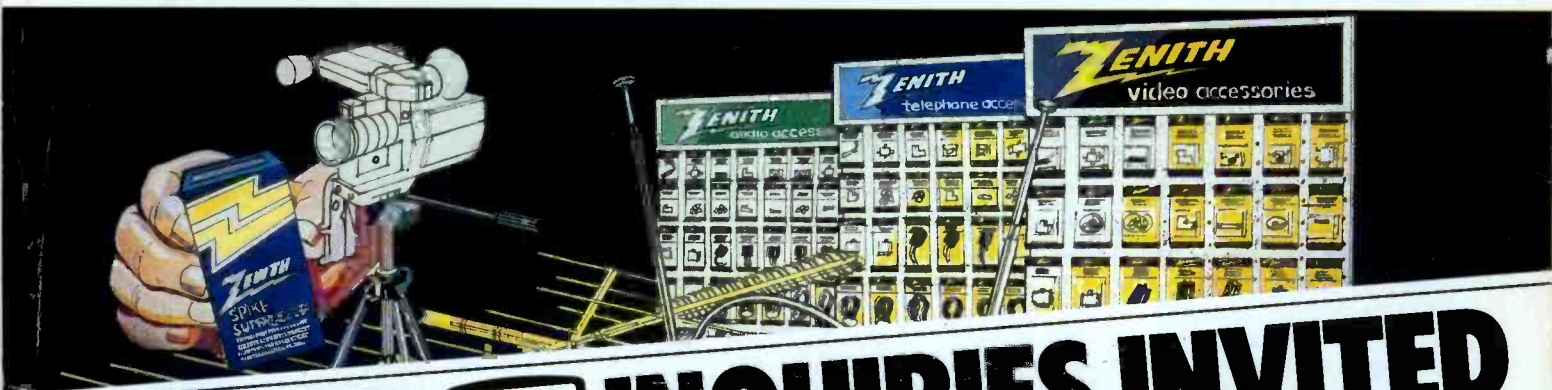

DEALER  **INQUIRIES INVITED**



SCAL-ATTACK